



Ness ECO8x ALARM CONTROL PANEL

USER'S MANUAL

A\$15.00

Rev 1.4



Security Products

www.ness.com.au



*“Australia’s largest designer
and manufacturer of
high quality security products”*



Head Office:
Ness Security Products Pty Ltd
ABN 28 069 984 372
4 / 167 Prospect Hwy
Seven Hills NSW 2147 Australia
Ph +61 2 8825 9222
Admin Fax +61 2 9838 8508
ness@ness.com.au

SYDNEY
Ph 02 8825 9222
Fax 02 9674 2520
sales@ness.com.au

MELBOURNE
Ph 03 9875 6400
Fax 03 9875 6422
nessmelb@ness.com.au

BRISBANE
Ph 07 3399 4910
Fax 07 3217 9711
nessbris@ness.com.au

PERTH
Ph 08 9328 2511
Fax 08 9227 7073
nessper@ness.com.au

ADELAIDE
Ph 08 8152 0000
Fax 08 8152 0100
adelaide@ness.com.au



NESS SECURITY PRODUCTS
Australian Communications Authority
TELECOMMUNICATIONS COMPLIANCE



ECO8x USER'S MANUAL
This revision February 2008

Document Part Number: 890-355

For products:
106-030 ECO8x Control Panel

WARNING

Installation and maintenance shall be performed by qualified service personnel only.

CAUTION

Risk of explosion if battery is replaced by an incorrect type. Dispose of used batteries according to the instructions on the battery.

ADSL NOTICE

ADSL broadband data can interfere with the operation of your alarm dialler.

It is recommended that a quality ADSL filter be installed as per the filter manufacturer's guidelines in all premises with an alarm dialler installed.

COPYRIGHT NOTICE

All rights reserved. No part of this publication may be reproduced, transmitted or stored in a retrieval system in any form or by any means, electronic, mechanical, photocopying, recording, or otherwise, without the prior written permission of Ness.

Ness reserves the right to make changes to features and specifications at any time without prior notification in the interest of ongoing product development and improvement.

© 2008 Ness Security Products Pty Ltd ABN 28 069 984 372

CONTENTS

- Features 4
- Introduction 5
- Keypad 6
- Visual Indicators..... 7

- OPERATION
- System Overview 9
- Arming 10
- Disarming..... 11
- Home Mode 12
- Keypad Panic / Duress 13
- Keypad Medical Alarm 14
- Keypad Fire Alarm 14
- Excluding Zones..... 15
- View Memory 16, 17
- Temporary Day Zones 18, 19

- PROGRAMMING
- Programming Options Table 20
- User Code programming 21
- Entry/Exit Timer programming 22

- Monitoring 23
- Ness Accessories..... 24, 25
- Troubleshooting 26
- Installation Record 27

- OPERATION SUMMARY 28

NESS ECO8x FEATURES

- 8 alarm zones.
- Supports up to 3 remote keypads.
- 15 user codes can be programmed to operate by keypad PIN or radio key.
- Optional Ness Radio Interface for fully integrated wireless security.
- Programmable 2 Area Partitioning can split the panel into two independent areas plus a common area.
- Home Mode allows partial arming, (eg, perimeter security overnight).
- Day Mode feature allows daytime monitoring of fire doors, coolrooms etc.
- Temporary Day Zone feature allows easy enabling/disabling of Day Mode.
- Keypad Panic feature.
- Keypad Medical Alarm feature.
- Two button arming feature.
- Fire Alarm feature with different siren tones.
- Highly flexible zone to output mapping.
- Onboard Vibration Sensor Analyser with programmable sensitivity. Use with Nessensor™ vibration sensors.
- Siren chirp and strobe flash on arming with radio key.
- Quiet chirps option on arm/disarm by radio key.
- True Dynamic Battery Test actively tests the battery under load every hour.
- 2 programmable auxiliary outputs.
- Automatic reset fuses.
- Programmable siren/reset lockout.
- 30 event memory from keypad.
- Standard defaults to suit most applications.
- Easy programming by keypad or NessComms™ software.
- All programming data is permanently stored in a non-volatile memory.
- All inputs and outputs are heavily protected against lightning and high voltage supply transients.

DIALLER

- Full remote upload/download by PC and modem using NessComms™ software.
- Contact ID Format for central station monitoring.
- Audible format feature.
- Phone line monitoring (activates output).
- Dialler 'Listen in' option for installers.
- Auto Test calls.
- DTMF dialling.
- True dial tone detection.

The Ness ECO8x microcomputer based 8 zone **control panel** is the heart of your security system.

Each **Zone** of the panel can be connected to one or more detection devices to protect separate rooms of your premises.

Detection devices may be wired to the panel or you can use optional wireless detectors.

Passive Infra-Red motion detectors (**PIRs**) are used to detect motion of people or animals. **Pet Aware** motion detectors can ignore pets and still detect people. **Reed Switches** are fitted to windows and doors to detect opening. **Vibration sensors** such as the **Nessensor™** can be used to detect glass breakage or forcing of windows or doors.

Normally a zone is considered **Sealed**. Activation of a detection device will cause the zone to be **Unsealed** and may cause an alarm.

Detectors such as smoke detectors and panic buttons must be able to generate an alarm at all times regardless of the panel setting. A zone with this assignment is called a **24 hour zone**.

Some detection devices may be required to generate an alarm or warning only when the panel is Disarmed. A zone with this assignment is called a **Day zone**.

Before leaving the premises you must "**Arm**" (turn on) the panel. After arming, the panel will ignore detectors during the **Exit Delay Time** to allow you to exit without triggering an alarm.

The system can be armed and disarmed using the keypad supplied or by optional Radio Keys.

When you enter the premises the panel will ignore selected zones for the **Entry Delay Time** and will not alarm if you disarm the panel during this allowed time.

When an alarm occurs, it can be reset with a **User Code**¹ or by optional Radio Key, otherwise it will reset at the end of Alarm Reset Time. Resetting an alarm stops the sirens and strobe light. If an alarm is not reset the sirens will stop after the programmed time (default is 5 minutes) and the strobe light will stop after 72 hours.

Home mode allows you to Arm selected zones while others are ignored. Typically, perimeter zones (doors and windows) can be monitored while you are at home.

If you wish to split your alarm system into two areas with access limited to each area by code numbers then **Area operation** is used. Radio Keys can also Arm and Disarm Areas.

The control panel housing and the covers over external sirens are protected by **tamper switches** to detect someone attempting to disable the security system.

You can **Exclude** a zone or zones so that they are temporarily ignored and cannot generate an alarm. Excluded zones become active again the next time the system is disarmed.

The control panel is fitted with a **rechargeable backup battery** to ensure your security system continues to operate if the mains power is interrupted. This control panel automatically tests the battery every hour and whenever you Arm/Disarm the panel. (**Dynamic Battery Test**).

Up to 30 previous events/alarms are stored in memory and can be viewed at any time in **Memory Mode**.

¹ Keypad codes programmed as ARM ONLY will not reset the panel.

KEYPAD

The ECO8x keypad provides important visual and audible indications and is the main interface for operating and programming the control panel.

The keypad features backlit soft-touch buttons and bright easy to read indicators. The Arm, Home, Memory and Exclude buttons are illuminated from behind allowing the system status to be seen at a glance.



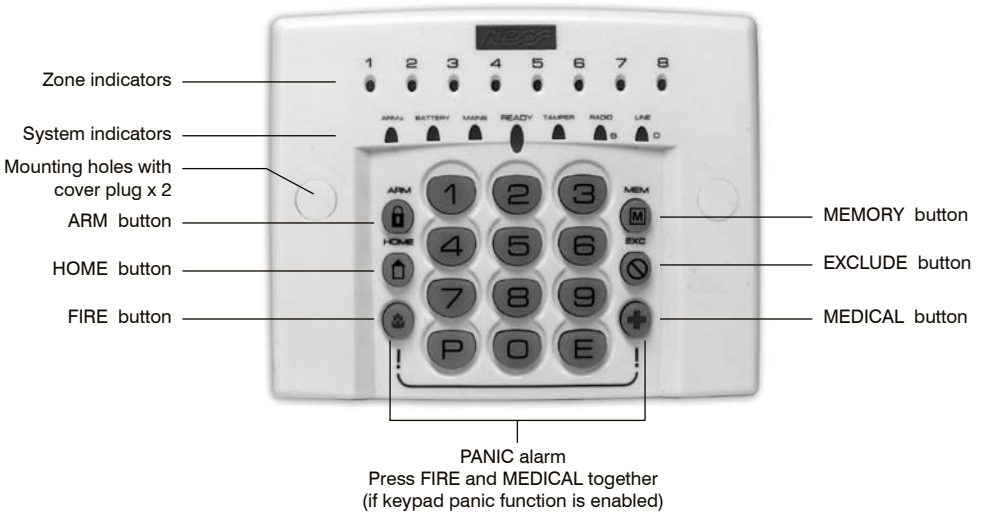









There is also an option to blank all the indicator lights after four minutes of no keypad use. (This option must be enabled by your installer.)



KEYPAD BEEPS	MEANING
♪ 1 BEEP	Any key press
♪♪♪ 3 BEEPS	Valid Command
♪ — ♪ 1 LONG BEEP	Error
♪-10-♪ 10 BEEPS	Mains Power is off or Panel Battery is low or A Radio Device has sent a low battery signal or Telephone Line Fail has been detected

KEYPAD INDICATORS

KEYPAD DISPLAY INDICATORS IN OPERATING MODE

KEYPAD LIGHT	OFF	ON	FLASHING
ZONE LIGHTS 1-8	Zone is sealed.	Zone is unsealed.	Zone is in alarm.
 ARMED Red Illuminated button	Panel is disarmed.	Panel is armed (or Area 1 is armed if using Areas).	
 HOME Amber Illuminated button	Home Mode is disarmed.	Panel is armed in Home Mode.	Day Mode enabled, (see page 18).
 MEMORY Red Illuminated button	Normal.	Memory mode selected.	New alarm/s in memory.
 EXCLUDE Red Illuminated button	Normal.		Zone/s are Excluded.
 PROGRAM Red Illuminated button	Normal.	User Program Mode.	Installer Program Mode.
<small>ARM2</small>  ARM2 (Amber)	Area 2 is Disarmed.	Area 2 is Armed.	
<small>BATTERY</small>  BATTERY (Red)	Normal.		The backup battery is low.
<small>MAINS</small>  MAINS (Red)	Normal.		Mains power is off.
<small>READY</small>  READY (Green)	Zone/s are unsealed. or Power is off. or Panel is armed. or phone line fault.	Ready to arm the panel.	
<small>TAMPER</small>  TAMPER (Red)	Normal.		The Internal Tamper input is in alarm.
<small>RADIO</small>  RADIO (Red)	Normal.	Receiving a radio signal. (If radio fitted.)	A Radio Key or other radio device has low battery.
<small>LINE</small>  LINE (Red)	Normal	Dialler is on line.	Phone line fault or failure to communicate.

See page 17 for keypad indicators in Memory Mode.

OPERATION

This section describes the operation of a typical control panel installation. Keep in mind that your installation may vary depending on the selected options and equipment. The operating instructions which follow will cover the most common options.

Consult your installation company if you require further information.

All control panel operations are controlled by the keypad except if an optional key switch or radio remote control is installed.

OPERATING RULES

Generally, the panel will be Disarmed. Armed or Home modes provide different levels of security for your premises when you are home or away. Three other temporary modes; Program, Memory and Exclude, allow you to perform various operations. The panel will automatically exit from these temporary modes if you do not press any buttons on the keypad in a 4 minute period.

If you make a mistake while entering any codes, press the E button and start again.

When you are required to enter your access code, you are given five opportunities to enter it correctly. After the fifth invalid attempt the alarm is activated (requiring the correct code + E to silence the alarm). This prevents anyone trying to guess your code by entering random numbers.

AREA PARTITIONING

Area Partitioning allows the zones to be split into two partitions; Area1 and Area2.

The panel then effectively operates as two separate systems sharing only the siren outputs and dialler.

USER CODE ASSIGNMENT

A User Code assigned to an Area can Arm and Disarm only that Area. User Codes assigned to both Areas will operate both Areas simultaneously.

COMMON AREA ZONES

Zones assigned to both Areas are Armed only when Area1 and Area2 are both Armed. This allows the Common Area zone/s to be shared by both Areas.

For example, Office A and Office B operate as separate areas but the entrance foyer used by both offices is assigned to both areas meaning it will automatically Arm when both Areas have Armed. The Common Area then automatically disarms when either Area1 or Area2 Disarms.

ARMING AREAS

Arming and Disarming of Areas, if enabled, is carried out as normal from a single keypad or separate keypads installed in both areas or by Radio Key.

Area operation only applies to zones when they are in the Armed state. This means that Day, 24hr and Home zones are independent of the area operations.

Note: Area partitioning is in addition to Home Mode. Any zone may be allocated to any area.





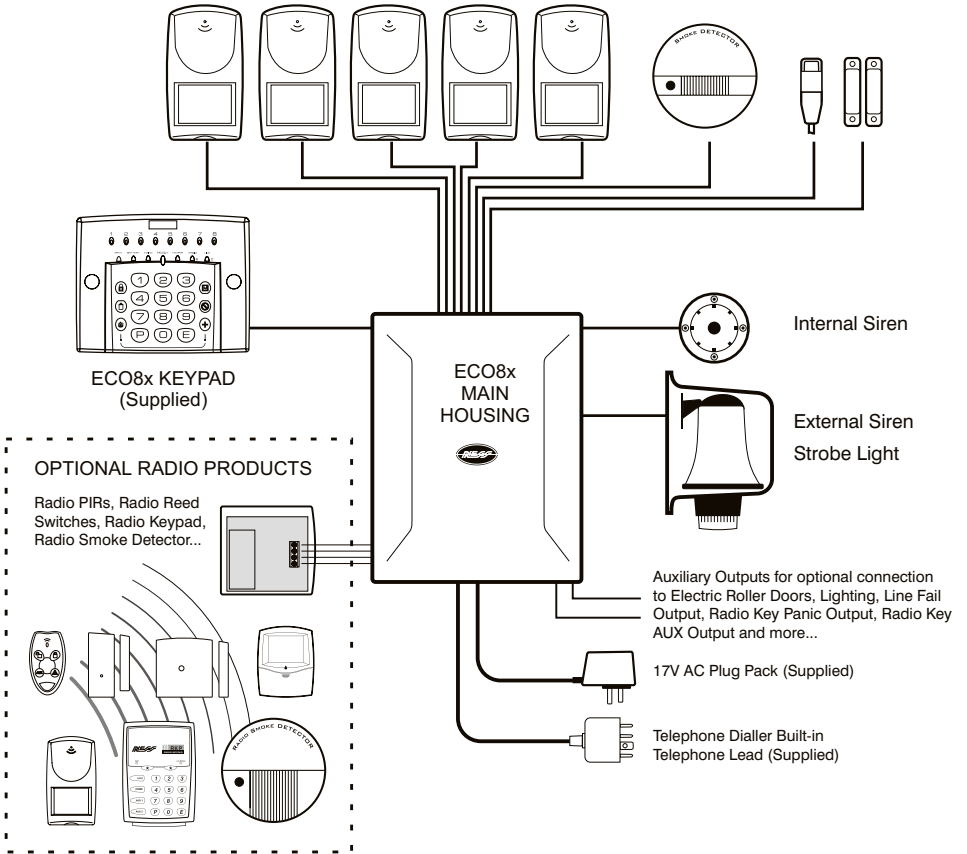

SYSTEM OVERVIEW

8 Zones for PIRs, Door & Window Switches, Vibration Sensors, Smoke Detectors...

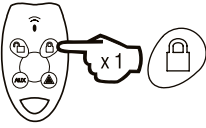

See pages 24-25 for further information on the Ness range of wired and wireless accessories.

OPERATION

To ARM the panel	
by KEYPAD	by RADIO KEY
<p>When the READY light is on, you can arm by...</p> <p>Press  + </p> <p>(If the ARMING SHORTCUT is enabled).</p>	<div style="text-align: center;">  </div> <p>Press the ON button once. The strobe light will flash briefly. If required, your installer can program the external siren to <i>chirp</i> once when disarming by radio key. (If Home Arming by Radio Key is enabled, the chirp will be delayed by 5 seconds).</p>
<p>Or press  + [USER CODE] + </p>	
<p>Or press [USER CODE] + </p> <p>(If CODE ONLY ARMING has been enabled by your installer).</p>	
<p>The ARMED BUTTON will light up. Leave the premises within the <i>Exit Delay Time</i>. 3 beeps will sound at the end of <i>Exit Delay Time</i>.</p>	

The control panel must be armed in order to detect intruders.

Before arming, all zones should be **Sealed** by making sure there is no movement in rooms protected by motion detectors. Doors or windows protected by reed switches should be closed.

The panel cannot be armed if in Program, Home, Memory or Exclude modes or if it is in alarm. (User codes that are programmed as *Arm Only** codes can arm the panel either from the disarmed state or from Home Mode.

A keypad is supplied with the panel. Operation by Radio keys is optional.

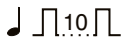
 10 beeps when you arm means Mains Power is turned off or the backup battery is low.

 One long beep when you arm could mean the panel is already armed or the keypad code is wrong, (if not using Shortcut Arming).

SIREN WARNING:

At the end of the exit time, all zones should be **Sealed**. If any are **Unsealed**, the siren will sound for 2 seconds to indicate that those zones have been automatically excluded. You should disarm the panel, check the premises and then arm again. Continual warnings could mean there is a problem with a detection device - that zone may have to be manually excluded.

If a zone is Unsealed at the end of exit time and the auto-exclude option is disabled, the siren will sound for the duration of siren time, (default is 5 minutes).

* This is an installer programming function.

To DISARM

by KEYPAD

Enter the premises via a Delay Zone.

Press **[USER CODE]** + **(E)**

by RADIO KEY

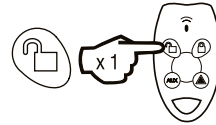

Press the OFF button once.

The strobe light will flash briefly.

If required, your installer can program the external siren to *chirp* 3 times when disarming by radio key.

The ARMED LIGHT will turn off. If there has been an alarm while the system was armed the MEMORY light will be flashing. See page 16 on how to read the event memory.

When you enter the protected premises through a delay zone, the keypad responds with regular beeps¹ as a reminder to Disarm. You then have your programmed entry delay time to disarm the panel.

If the panel is not disarmed by the end of the entry delay time, an alarm will occur.

By using the optional radio keys you may disarm your system from within your premises or from outside your entrance door. There is also the option to 'Chirp' the outside siren three times and briefly flash the strobe light to indicate that you have disarmed your system.

If you make a mistake when entering your keypad code press E and start again. Five incorrect entries will cause an alarm.

The panel can be reset and the siren/s silenced by disarming the panel.

If you arrive at your premises and find the strobe light flashing² (if installed), reset the panel as above. To check the cause of the alarm, you can view the alarms in memory by entering Memory Mode.

Note: Arm Only codes





User codes can optionally be programmed to be *Arm Only*³ codes. An *Arm Only* code can Arm the system but it cannot Disarm. However if an *Arm Only* code is assigned to a radio key, the radio key OFF button will arm and disarm.

¹ If Entry Beeps are enabled.

² In the event of an alarm, the strobe light will flash for 72 hours or until the panel is reset.

³ This is an installer programming function.

OPERATION

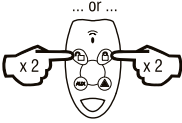
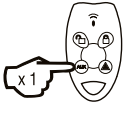
To arm HOME Mode	
by KEYPAD	by RADIO KEY
<p>Press  + </p> <p>(If the HOME MODE SHORTCUT is enabled).</p>	<p>Home mode arming by radio key must be enabled by your installer.</p>
<p>Or press  + [USER CODE] + </p>	<div style="display: flex; justify-content: space-around;"> <div style="text-align: center;"> <p>... or ...</p>  </div> <div style="text-align: center;">  </div> </div> <p>Press either the OFF button or the ON button twice within 4 seconds.</p> <p>Or press the AUX button once. (RK4 radio key only, if enabled).</p>
	<p>The strobe light will flash briefly.</p> <p>If required, your installer can program the external siren to <i>chirp</i> twice when arming Home mode.</p>

Home mode allows you to Arm selected zones while others are ignored. Typically, perimeter zones (doors and windows) can be monitored while you are at home.

Your installer must program which zones will be active in Home mode.

If an alarm occurs while in Home mode, entering [USER CODE] +  will silence the alarm. This will also Disarm the panel, so remember to arm Home Mode again if needed.

Using the optional Radio Keys you can enter Home Mode by pressing either the OFF button or the ON button twice within 4 seconds or by pressing the AUX button, (RK4 radio key only). These options must be enabled by your installer.

Notes on Home Mode and Areas.

Home Mode can be used if the panel is fully disarmed or if only Area2 is armed. Home mode is not available when Area 1 is armed.

The panel can be armed in Home Mode if Area2 is already armed on these conditions:

- Area 1 must be OFF.
- Area 2 must be armed first, and then Home armed – not the reverse.
- Zones assigned to both Home Mode and to Area 2 will act as Home zones when both Area 2 and Home Mode are armed.

Note: Home Mode arming when AREA 2 is armed cannot be done by Radio Key or by keyswitch.

PANIC alarm

by **KEYPAD**

Press  + 
Fire & Medical keys together

by **RADIO KEY**

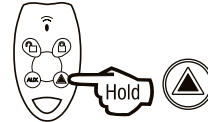

Press and hold the PANIC button for at least 4 sec.

The keypad function may have been programmed to be either **AUDIBLE** to activate the sirens, or **SILENT** to send a PANIC report by dialler if your system is monitored by a Central Station.

PANIC cannot be used while the panel is in Program mode.

Note: Your installer may also have installed a separate wired PANIC button.

Press [USER CODE] +  to reset a Panic alarm, or press the OFF button on a radio key.

Keypad DURESS alarm

by **KEYPAD**

Press [5, 6, 8 OR 9] + [USER CODE] + 

Add one these digits in front of a user code when disarming.

This sequence will disarm the panel and send a Duress report by dialler if the system is monitored by a central station.

The DURESS alarm can be used to send a silent alarm to the central station that you are being forced to disarm the panel against your will. That is; you are disarming under "duress."

To disarm and send a DURESS alarm, prefix your User Code with one of the digits 5, 6, 8 or 9 when Disarming.

* THE KEYPAD DURESS IS NORMALLY NOT ENABLED. TO ENABLE THIS FUNCTION, CONSULT YOUR INSTALLER.

* DURESS ALARMS CAN ONLY USED BY SYSTEMS WHICH ARE MONITORED BY A CENTRAL STATION.

* THE DURESS ALARM CAN BE PROGRAMMED TO SOUND THE INTERNAL SIREN (RESET OUTPUT). THIS OPTION IS OFF BY DEFAULT.

OPERATION

Keypad **MEDICAL** alarm

by **KEYPAD**

Press  + 

Sends a Medical Alarm report by dialler.

(If this option has been enabled by your installer and the system is monitored by a central station).

The Medical Alarm does not sound the sirens.

Keypad **FIRE** alarm

by **KEYPAD**

Press  + 

Sounds the siren using the Fire Alarm sound.

(If Keypad Fire Alarm has been enabled by your installer).



And sends a Fire Alarm report by dialler.

(If this option has been enabled by your installer and the system is monitored by a central station).

How to EXCLUDE zones**by KEYPAD**

Press  + 
(If the EXCLUDE SHORTCUT is enabled)

Or press  + **[USER CODE]** + 
The Exclude light will turn on.

then press **[ZONE No.]** +  **[ZONE No.]** +  (Enter the zone number/s to be excluded.)
Zones 1–8 can be excluded.

then press  to exit Exclude mode

The Exclude light flashes constantly while zones are excluded. Excluded zones are automatically included next time the panel is disarmed.

If there is a problem with a detection device and the zone cannot be sealed when arming the panel, then that zone can be Excluded so that it does not generate alarms.



When zones have been Excluded, the EXCLUDE light flashes continuously (in both the Disarmed and Armed state).



Zones can be excluded while the panel is either Disarmed or Armed. See notes below.

Zone Exclude is not permanent. Excluded zones are automatically included next time the panel is Disarmed.

Zones can be manually included by the same method as Excluding. Simply use the **[ZONE No.]** +  sequence to turn OFF the zone lights to be Included.

NOTES

The  +  method works only when the panel is Disarmed.

The  + **[USER CODE]** +  method works even when the panel is armed.
(This method can only exclude the zones in the Area assigned to that code.)

OPERATION

Viewing the EVENT MEMORY

by KEYPAD

Press  + 

(If the MEMORY SHORTCUT is enabled)

Or press  + [USER CODE] + 

The Exclude light will turn on.

Press  ...The most recent event will be displayed.

Press  ...The next most recent event will be displayed.

Press  ...and so on, up to 30 events.

Press  to exit Memory Mode.

The panel stores a comprehensive event memory, including Arming, Disarming, Low Battery, Mains Fail and Alarm events.

The memory is constantly upgraded and the last 30 events are always available for viewing.

This memory display can only be selected while the panel is in the Disarmed state.

TO CLEAR THE MEMORY LIGHT

The  MEMORY light flashes continuously when an alarm has occurred as a reminder to view the alarm memory. The MEMORY light stops flashing after the memory is viewed as shown above.

The MEMORY light is automatically cleared next time the panel is Armed.

When reviewing the event memory, the keypad lights will show the stored events as shown on this table.

MEMORY MODE - EVENTS INDICATED BY KEYPAD LIGHTS	
INDICATOR ON THE KEYPAD	MEMORY EVENT
ZONE LIGHTS 1–8	Zone alarm
(no lights)	Panel Disarmed
ARMED	Panel Armed (or Area 1 Armed)
ARM2	Area 2 Armed
MAINS	Mains power failure
BATTERY	Low Battery
TAMPER	Tamper alarm (Siren cover, panel etc)
EXCLUDE	Panic alarm
LINE	Telephone line fail
RADIO, EXCLUDE	Radio Key Panic alarm
RADIO, BATTERY, ZONE	Radio Device battery low, (Device number is indicated by a zone light)
RADIO, BATTERY, ARM	Radio Key battery low, (Radio Key number is NOT indicated)
RADIO, TAMPER, ZONE	Radio Device tamper alarm, (Device number indicated by a zone light)

TEMPORARY DAY ZONES

The Ness ECO8x control panel has a Temporary Day Zone feature which allows easy and flexible Day Zone selection and operation.

Temporary Day Zones operate in addition to Permanent Day Zones which are usually setup by the installer.

While remaining in normal operating mode, the user can add and remove 'Temporary Day Zones'.

As an extra feature, the user can easily enable or disable Day Mode, (which includes both Temporary and Permanent Day Zones).

Day Zones can be programmed by your installer to beep the keypad, or briefly sound the siren/s or flash the strobe light.

TYPICAL APPLICATIONS

Day Zones are useful for a variety of applications such as a shop door beeper, triggered by a reed switch on the door.

For example, in a shop you could enable Day Mode to alert you when a customer enters the front door.

You can also enable additional Temporary Day Zones to monitor switches on, for example, the rear door or the fridge doors.

COMMANDS

(Accessed from normal operating mode).

ENTER SELECTION MODE.

Press **(P)** followed by **(E)** when in operating mode to enter Temporary Day Zone selection mode.

ZONE SELECTION.

[ZONE No.] + **(E)**

To select or deselect zones to be Temporary Day Zones. The selected zones are indicated by the corresponding zone number.

Permanent Day Zones, (installer option P53E), are not displayed in selection mode. Permanent Day Zones can be selected as Temporary Day Zones but this has no effect as those zones are already day zones.

EXIT SELECTION MODE.

Press **(E)** to save changes and return to normal operating mode.

ENABLE DAY MODE.

Press **(O)** + **(E)** to enable/disable Day Mode.

When Day Mode is enabled, any unsealed day zone will sound the programmed output for 2 seconds. When Day Mode is disabled, an unsealed day zone will simply be indicated on the keypad as an unsealed zone.

The **(H)** HOME light flashes continuously when Day Mode is enabled

Programming your Ness ECO8x is a simple process using the keypad.

To enter program mode you need to know your Master Code, which is user code number 1, (see the table on the next page).

If you forget your Master Code it can be reset by your installer.

USER CODES

The ECO8x panel has 15 user codes which can be operated by keypad code (3-6 digit PIN) or by optional radio key.

To add, change or delete a keypad code, follow the steps on page 21.

To add or delete radio keys, ask your installer.

The panel is supplied with the Master Code pre-programmed as 123. You should re-program this code with a new code of your own choice.

TIMERS

You can also re-program the Entry Delay Time and Exit Delay Time if you need more or less time to exit and enter the premises.

MONITORING

Your installer can program the ECO8x to report alarms via the onboard dialler to either your mobile phone or to a central monitoring station.

Ask your installer for details.

TO ENTER USER PROGRAM MODE

From the disarmed state.

Press **(P)** + **[MASTER CODE]** + **(E)**

The factory default Master Code is 123.

The **(P)** button will light up in red while in User Program Mode.

TO EXIT PROGRAM MODE

Press **(P)** + **(E)**

The **(P)** button light will turn off.

NOTE 1. The panel will automatically exit Program Mode if the keypad is inactive for 4 minutes.

NOTE 2. The Panic alarm is be disabled while in Program Mode.

PROGRAMMING OPTIONS TABLE

OPTION NO.	DESCRIPTION	DEFAULT	USER'S NAME
P11E	User Code 1 (Master Code)	123	
P12E	User Code 2		
P13E	User Code 3		
P14E	User Code 4		
P15E	User Code 5		
P16E	User Code 6		
P17E	User Code 7		
P18E	User Code 8		
P19E	User Code 9		
P20E	User Code 10		
P21E	User Code 11		
P22E	User Code 12		
P23E	User Code 13		
P24E	User Code 14		
P25E	User Code 15		

OPTION NO.	DESCRIPTION	DEFAULT	COMMENT
P26E	Entry Delay Time	20 (20 sec)	Programmable from 1–99 seconds.
P28E	Exit Delay Time	60 (60 sec)	Programmable from 1–99 seconds.
P29E	Siren Reset Time*	5 (5 min)	Programmable from 1–99 minutes. Siren times of longer than 5 minutes are contrary to noise pollution regulations in most areas.

* Siren Reset Time applies to the internal and external siren outputs. The strobe light will reset after 72 hours unless the panel is reset sooner.

Programming USER CODES

STEP	KEYSTROKES	DESCRIPTION	COMMENT
1	Press P + [MASTER CODE] + E	Enters User Program Mode.	The P button will light up in red.
2	Press P + [OPTION No.] + E	Enter the 2 digit option number for the user code being programmed.	The existing user code, if any, will be displayed by the keypad one digit at a time.
3	[NEW CODE] + E [NEW CODE] + E	Enter the new user code twice for verification. Keypad codes can be 3-6 digits long.	The new user code will be displayed by the keypad one digit at a time.
4	P + E	To exit User Program Mode.	The P light will turn off.

A keypad code can be deleted by pressing **M** + **E** at STEP 3 above.

i When re-programming an existing keypad code, the new code will overwrite the old code. A keypad code only needs to be deleted if you're not replacing it with a new code.

EXAMPLES

The panel must be in program mode.

- To program User Code 1 to be 1234: Press P11E 1234 E 1234 E
- To delete User Code 2 without programming a new code: P12E **M** E

USER CODE PROGRAMMING RULES:

- Up to 15 Keypad Codes can be used at up to 3 wired keypads for controlling all panel functions including Arming/Disarming, Home Mode, Panic, memory recall and much more.
- Keypad Codes can be 3 to 6 digits in length and can be individually programmed and deleted.
- User Code 1 is also the Master Code which is used to enter User Program mode.
- All User Codes are Keypad Codes by default. User Codes can be programmed to be Radio Codes as required.

NOTES

1. Keypad Codes beginning with 0 (zero) can be programmed but they will not operate the panel. This is an alternative method for disabling user codes.
2. All codes must be unique to each other. Codes are rejected if already used. Some codes that are similar to existing codes may also be rejected.
3. When re-programming a Keypad Code, the old code does not need to be deleted first. The new code will overwrite the old code.

PROGRAMMING

Programming TIMERS			
STEP	KEYSTROKES	DESCRIPTION	COMMENT
1	Press P + [MASTER CODE] + E	Enters User Program Mode.	The P button will light up in red.
2	Press P + 2 6 + E ...or Press P + 2 8 + E	Enter the option number for Entry Delay Time 1. Or enter the option number for Exit Delay Time.	The existing time, if any, will be displayed by the keypad one digit at a time.
3	[NEW TIME] + E	Enter the new time in seconds. Example, enter 25 seconds as 25 + E.	The new time will be displayed by the keypad one digit at a time.
4	Press P + E	To exit User Program Mode.	The P light will turn off.

See page 20 for the entry and exit delay factory default settings.

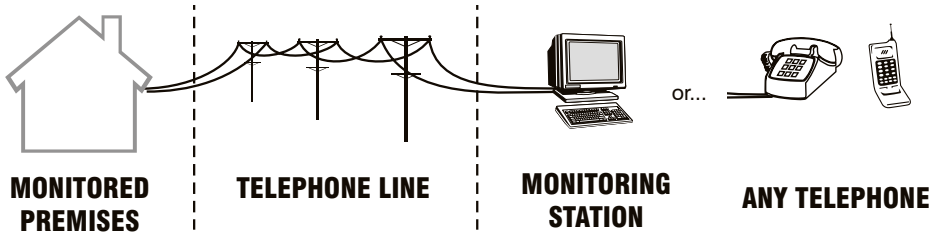

CENTRAL STATION MONITORING

The Ness ECO8x control panel has an on-board digital dialler which can send detailed alarm messages to a Central Monitoring Station.

The digital messages can include information about the zone or zones which caused the alarm, tamper alarms, low battery or mains failure reports, and it can also (by user number) identify the users who arm and disarm the system.

Central station monitoring is highly recommended and is the most effective method of monitoring your alarm system.

For further information about 24 hour monitoring, contact your installer or Ness Security Products.

AUDIBLE MONITORING



As a lower security alternative to central station monitoring, the panel can be programmed to send audible messages to a fixed or mobile phone.

The telephone number/s to call need to be programmed by your installer.

When triggered by an alarm, the dialler will call the programmed telephone number/s and output the audible message for 45 seconds or until it is acknowledged.

The audible message consists of the warning words ALARM, ALARM, ALARM followed by the alarm message sent as a series of beeps

ACKNOWLEDGING THE ALARM

The person receiving the call can then acknowledge the alarm by pressing the  key on their telephone. Press the  key for at least 2 seconds after the alarm beeps.

If the alarm is not acknowledged, the LINE light on the keypad will flash continuously until the panel is next armed.

NESS ACCESSORIES

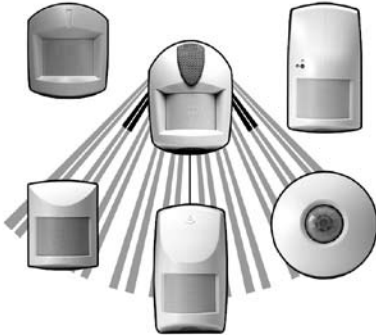

QUANTUM™



NESS
CCTV Products

Consistent™
Commitment
To
Value

NESS QUANTUM DETECTORS

The Ness Quantum™ range of high-tech motion detectors includes passive infrared detectors, dual technology microwave and infrared, as well as ceiling mounted 360° detectors.

All Ness detectors are designed and manufactured using the most modern technology and techniques that ensure superior reliability and performance.

The Ness Quantum™ Pet Aware PIR and Pet Aware Dual have a superior ability to discriminate between household pets and unwanted human intruders.

Ness Pet Aware detectors make it possible to protect your premises with your pets indoors. (Up to 25kg animal).



NESS CCTV PRODUCTS

The wide range of Ness CCTV equipment allows your installer to design a professional state-of-the-art system for your home, office, shop or factory.

Ness cameras include dome cameras, Infra-red illuminated cameras, miniature hidden cameras and professional digital cameras.

Video monitors are available in CRT or flat screen LCD styles in sizes to suit all applications.

Ness' acclaimed Digital Video Recorders store video footage on hard disk drives for fast and easy to retrieve 'tapeless' recording.

Ness DVRs are available in 4, 6, 9 and 16 channel models to suit all applications and all budgets, even mobile models for use in vehicles such as buses and trucks.

Most DVR models are 'Internet Ready' for instant connection to a LAN and broadband internet connection for remote viewing.

Ness CCTV means Consistent Commitment To Value.

OPTIONAL RADIO ACCESSORIES

Ask your installer about the range of Ness radio devices for the optional extra convenience of wireless remote control and wireless detection.

Operating your Ness security system can be as convenient as opening your car door. The Ness Radio Key™ provides the benefits of separate ON, OFF and PANIC buttons in a slim, waterproof remote control.

* Ness radio products require a Ness Radio Interface (100-200) to be fitted to the control panel.



RK4 Radio Key



RK3 Radio Key

RADIO KEYS

Fully waterproof, ultra slim 3 or 4 button Radio Keys for remote control of the control panel.

With separate buttons for ON (Arm), OFF (Disarm), PANIC and AUX functions (RK4 only). Including long life lithium battery.



RK1 Radio Key Pendant

RADIO KEY PENDANT

Fully waterproof pendant style transmitter can be used as a portable wireless Panic button.

Supplied with a neckchain as well as wristwatch straps. Ideal for use as a medical alarm for the elderly or infirm. (Central Station Monitoring is especially

recommended when used for medical alarm purposes). Includes long life lithium battery.



RADIO REED SWITCH

Ness Radio Reed Switch for wireless door and window protection. Includes long life lithium battery.



NESS RADIO KEYPAD

A unique fully portable radio keypad. The Ness Radio Keypad provides totally wireless Arming/Disarming of the ECO8x control panel.

Also operates Home Mode and provides a Panic alarm.

The Ness radio Keypad is suitable for use as a portable keypad or for adding an extra keypad in areas where it is not possible to install wires.



R15 Radio PIR



R12 Radio PIR



RADIO MOTION DETECTORS

Ness R15 Radio PIR and Ness R12 Radio PIR for wireless motion detection.

Can be used in combination with Ness hardwired detectors in areas where it is not possible to install wires. Includes long life lithium battery.

The Ness R15PET Pet Aware model detects humans but is immune to household pets. Allows you to protect your home with your pets inside.

RADIO SMOKE DETECTOR



The Ness Radio Smoke Detector provides a fully wireless smoke detection option which can trigger the ECO8x panel's siren/s and dialler if required (or as programmed by your installer.)

The Ness Radio Smoke Detector uses Photo-electric smoke detection technology. On board sounder and test button for the sounder and radio transmitter. A single battery powers the smoke detector and the transmitter. Includes 9V lithium battery.

TROUBLESHOOTING

SYMPTOM	POSSIBLE CAUSE	REMEDY
When arming, a zone light is on or the keypad gives a long beep.	One or more detection device (a PIR or reed switch) may be <i>unsealed</i> .	Find the cause of movement or close the door or window.
<ul style="list-style-type: none"> • 10 beeps from keypad. • MAINS light is flashing. • BATTERY light is flashing. 	The mains power may be off, ...or the panel's backup battery may be low, ...or a Radio Device battery may be low.	Make sure the plug pack is plugged in and the power point is turned on. The backup battery may need replacing, call your installer.
1 long beep from the keypad.	Invalid keypad entry.	Press the E button and try again.
2 second siren at the end of Exit Delay time.	A zone was <i>unsealed</i> at the end of exit delay time.	Disarm the panel and check all zones.
The strobe light is flashing.	There has been an alarm within the last 72 hours.	Reset the alarm by disarming the panel and check the Alarm Memory
Siren sounds while the panel is disarmed.	A 24 hour zone has been alarmed. (Housing Tamper, Panic Button).	Reset the alarm by disarming the panel and call your installer.
EXCLUDE light is flashing.	A zone/s has been Excluded.	This is to indicate that one or more zones have been Excluded.
Cannot arm and the EXCLUDE light is on steady.	You are in Exclude mode.	Press E to exit Exclude mode.
TAMPER light flashing	The 24 hour Tamper input has alarmed. (Housing tamper).	Call your installer.
ALARM MEMORY light is flashing.	There are alarms in memory.	To clear the ALARM MEMORY light, view the Alarm memory otherwise the light will clear next time you arm the panel.
Cannot enter Program Mode.	The panel is armed. Or you may be attempting to enter program mode using one of the user codes.	Disarm the panel before attempting to enter Program Mode. Try again using the Master Code.
When I arm by radio key, the Armed light on the keypad does not turn on immediately.	The panel is waiting 5 seconds for a second press of the ON button to enter Home mode.	This is normal operation when arming of Home mode by radio key is enabled.

INSTALLATION RECORD



ECO8x

Date Installed:
Installation Company:
Telephone:
Monitoring Company:
Telephone:



















TIMERS - User Programmable	
Entry Delay Time (P26E)	Seconds
Exit Delay Time (P28E)	Seconds
Siren Reset Time (P29E)	Minutes

ZONE ASSIGNMENT - Installer Programming Options											
ZONE TYPES								ZONE MAPPING TO OUTPUTS			
Instant (P40E)	Entry (P41E)	Handover (P42E)	Area 1 (P45E)	Area 2 (P46E)	Home (P51E)	24 hr (P52E)	Reset (P54E)	Strobe (P55E)	Sonalert (P56E)	Siren (P57E)	Dialler report (P74E)

ZONE	DESCRIPTION
1	
2	
3	
4	
5	
6	
7	
8	

USER CODES - User Programmable						
OPTION NO.	DESCRIPTION	USER'S NAME	AREA		USER TYPE	
			1	2	KEYPAD	RADIO KEY
P11E	User Code 1 (Master Code)					
P12E	User Code 2					
P13E	User Code 3					
P14E	User Code 4					
P15E	User Code 5					
P16E	User Code 6					
P17E	User Code 7					
P18E	User Code 8					
P19E	User Code 9					
P20E	User Code 10					
P21E	User Code 11					
P22E	User Code 12					
P23E	User Code 13					
P24E	User Code 14					
P25E	User Code 15					

KEYPAD OPERATION SUMMARY

<p>to ARM</p> <p>The panel must initially be disarmed.</p>	<p>Press  +  (If the Arming Shortcut is enabled).</p> <hr/> <p>or press  + [USER CODE] + </p> <hr/> <p>or press [USER CODE] +  (If Code Only Arming has been enabled for that user code).</p>
<p>to DISARM</p> <p>To disarm and/or reset alarms.</p>	<p>Press [USER CODE] + </p>
<p>to arm HOME MODE</p> <p>Area1 must initially be disarmed.</p> <p>Home Mode can be used if the panel is fully disarmed or if only Area2 is armed, see page 12 for more information.</p>	<p>Press  + </p> <p>(If the Home Mode Shortcut is enabled).</p> <hr/> <p>or press  + [USER CODE] + </p>
<p>PANIC alarm</p>	<p>Press   Fire & Medical keys together</p> <p>(If Keypad Panic is enabled).</p>
<p>KEYPAD DURESS</p> <p>Keypad Duress allows the user to send a silent duress report while disarming, (if the system is being monitored by a central station).</p>	<p>Press [5, 6, 8 OR 9] + [USER CODE] + </p> <p>Add one these digits in front of a user code when disarming.</p> <p>This sequence will disarm the panel and send a Duress report by dialler to the central station. (Report Keypad Duress must be enabled by your installer).</p>
<p>EXCLUDE ZONES</p> <p>EXCLUDE + E can only be used when the panel is disarmed.</p> <p>EXCLUDE + CODE + E can be used anytime.</p>	<p>Press  +  (If the Exclude Shortcut is enabled).</p> <p>then [ZONE No.] +  [ZONE No.] +  (Enter the zone number/s to be excluded.)</p> <p>then press  to exit Exclude mode</p> <p>The Exclude light flashes constantly while zones are excluded. Excluded zones are automatically Included next time the panel is disarmed.</p>