



**SECURITY ALARM CONTROL PANEL**

*INSTALLER MANUAL*

---

*Contents*

System Specifications .....	2
PINKERTON Wiring Diagrams .....	3
PINKERTON Terminal Connections .....	4
PINKERTON Zone Input Connection Examples .....	5
Defaulting the PINKERTON System .....	6
Quick Start .....	7
Installer Code & Master Code .....	7
How To Change the Master Code (Local & Dialler versions) .....	8
How To Change the Telephone Numbers (Dialler version) .....	8
Programming – PINKERTON Local & Dialler versions .....	9
Binary Addresses .....	9
PINKERTON Keypad .....	10
Keypad indicator lights.....	10
Keypad Beeper Operation.....	10
PINKERTON Operation.....	11
Keypad Key Functions .....	11
Operation of all keys.....	11
Siren Output .....	16
Strobe Output .....	16
Changing Zone Configurations.....	19
Address Descriptions – PINKERTON Local & Dialler Versions.....	21
Programming – PINKERTON Dialler version .....	29
Dialler functions.....	32
Personal Reporting .....	32
Address Descriptions – PINKERTON Dialler Version .....	33
Remote access by telephone .....	35
Automatic test reports.....	36
Base station monitored reporting.....	37
PINKERTON Programming Quick Reference.....	38

**SYSTEM SPECIFICATIONS**

Panel Depth	78mm	Code Lockout time	60 sec
Panel Width	255mm	Non-volatile memory for options	Yes
Panel Height	305mm	Number of logical inputs to dialler	16
Panel weight (without battery)	2.2Kg	Restore reporting	Yes
Maximum operating ambient temperature	50°C	Ademco Fast format (with checksum)	Yes
AC supply voltage (via plug pack)	15V rms	Report types sent	Open/Close, System, Duress
DC supply voltage	11 - 14V		Test report, Input alarm report
Nominal battery charge voltage	13.75V	Maximum dialling attempts 00 to 09	
Maximum continuous D+ current	500mA	Fail to communicate triggers sirens option	Yes
Reverse battery protection	Yes	Ring detection	Yes
Charger fuse	1 Amp	No of rings to answer telephone	00 to 16
Power fuse	2 Amp	Automatic dialtone detection	Yes
Low battery detection voltage	11.45V	Decadic / Tone dial selection	Yes
Typical battery capacity	6.5 A/hr	Anti-jam logic	Yes
Supply current (idle)	50mA	Max. on-line time to monitoring station	4.25 min
Supply current (on-line)	160mA	Telephone connection mode	Mode 5
Additional current per DC driver on	20mA	Digital decoding / generation	Yes
Backup time (idle) external load 0mA	175hrs	Line isolation voltage	>1.5KV
Backup time (idle) external load 100mA	40hrs	EMI standard	AS3548 Class B
Backup time (idle) external load 200mA	20hrs	DTMF output level (typical)	-5 dBm
Maximum DC output current (intermittent)	2 Amp	Handshake receive sensitivity (typical)	-43dBm
Peak DC current output	5 Amp	Call progress tone sensitivity (typical)	-43dBm
End of line monitored inputs	Yes	DTMF decode sensitivity (typical)	-35dBm
End of line resistor value	4K7	DTMF decode minimum digit duration	45mSec
User code length	4 digits	Return loss (typical @ 1khz, 50mA)	20dB
Code attempts before code lockout	4	Maximum continuous line current	120mA

**PINKERTON WIRING DIAGRAMS**

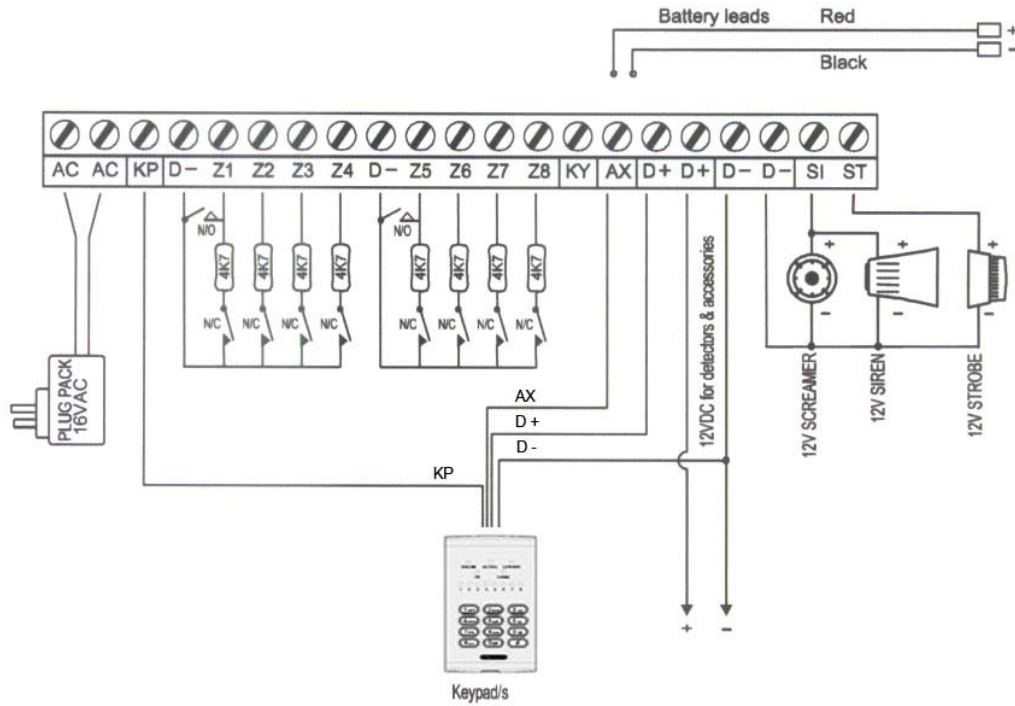

**External Inputs**

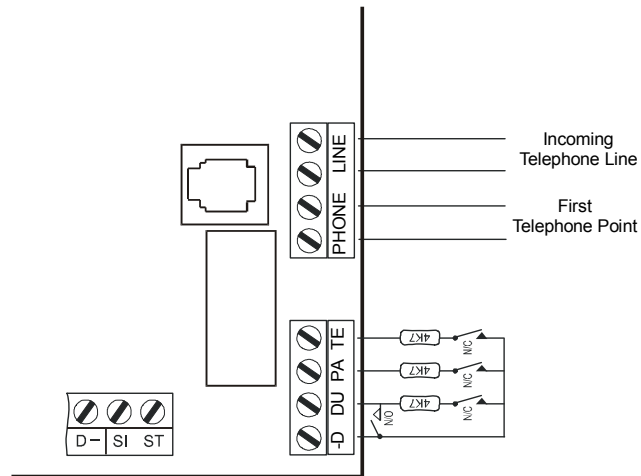

*Please Note: Phone Line Inputs (Dialler Version) is designed for the international market only and should not be used in Australia. Please use the telephone lead supplied with the panel.*

---

**PINKERTON TERMINAL CONNECTIONS**

AC	16VAC supply from plug pack.
AC	16VAC supply from plug pack.
KP	Remote keypad/s blue wire.
D-	Common for Zones
Z1	Zone 1 input. 4.7K end of line resistor.
Z2	Zone 2 input. 4.7K end of line resistor.
Z3	Zone 3 input. 4.7K end of line resistor.
Z4	Zone 4 input. 4.7K end of line resistor.
D-	Common for Zones
Z5	Zone 5 input. 4.7K end of line resistor.
Z6	Zone 6 input. 4.7K end of line resistor.
Z7	Zone 7 input. 4.7K end of line resistor.
Z8	Zone 8 input. 4.7K end of line resistor.
KY	Keyswitch input. Apply momentary negative voltage to arm or disarm the panel. Also used to restore the Installer code to factory default setting. Hold a negative voltage on KY while applying power to board.
AX	Remote keypad/s white wire.
D+	12VDC positive supply for detectors. Also remote keypad/s red wire.
D+	12VDC positive for supply to detectors.
D-	12VDC negative supply for detectors. Also remote keypad/s black wire.
D-	12VDC negative supply for detectors. Also common for siren and strobe.
SI	Siren output. 12VDC positive when in alarm.
ST	Strobe output. 12VDC positive when in alarm.
D-	Common for External Input Zones
DU	Duress input. 4.7K end of line resistor.
PA	Panic input. 4.7K end of line resistor.
TE	Test input. 4.7K end of line resistor.
LINE	Incoming Telephone Line.
PHONE	To First Telephone point.

# PINKERTON ZONE INPUT CONNECTION EXAMPLES

**Please Note:**

These wiring diagrams are general examples only. Refer to the installation guidelines supplied with each device.

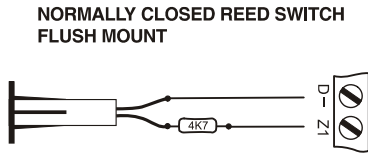
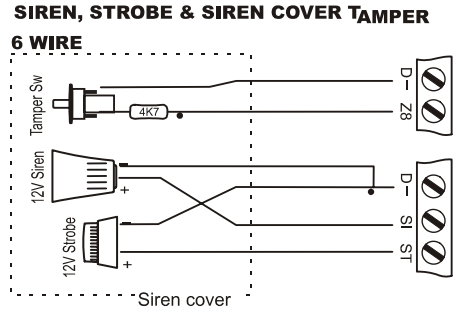
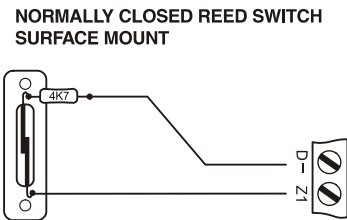
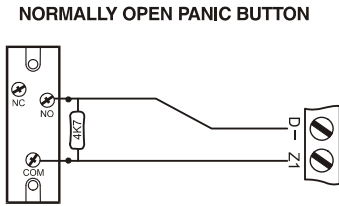
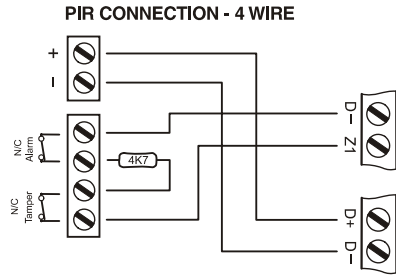

**Wireless Arm/Disarm and Panic Remote connection to Pinkerton Receiver RX2K / RX4K.**

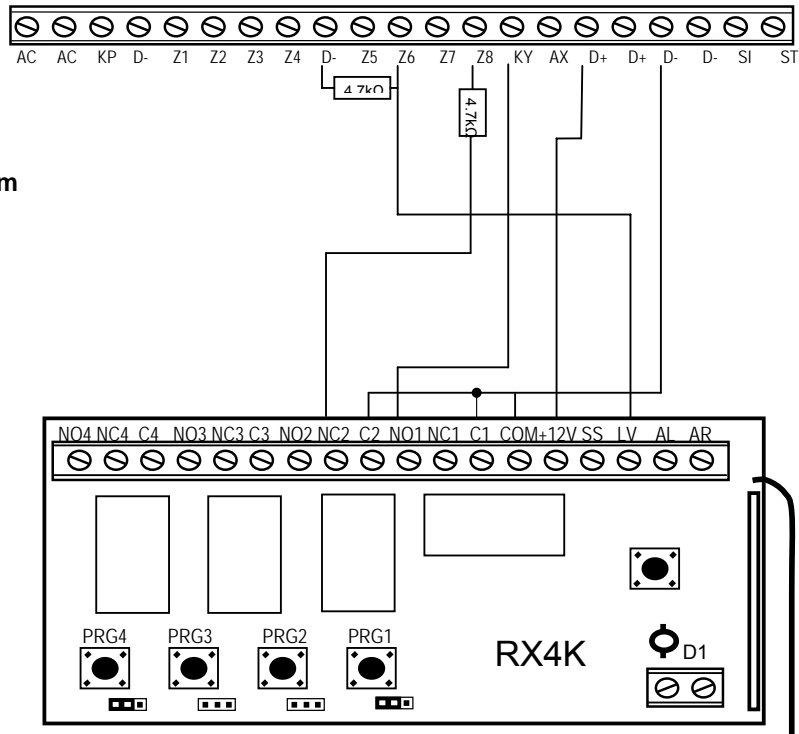

---

## DEFAULTING THE PINKERTON SYSTEM

### Setting the installer code to factory default of 2580

There are two ways of defaulting the SYSTEM:

#### 1. Defaulting only the installer code.

To default the INSTALLER CODE only, simply power up the panel with the KY input shorted to D-. Wait 5 seconds. Remove the KY short to D-. The installer code is now defaulted to 2580. (If address 255 was set to "9" then no code change was made)

#### 2. Setting all panel options back to a factory default.

To set the PINKERTON options back to factory default, use the installer code to go into programming mode and set lights at address 250 (Yes/No option) as below. The below options will automatically be set to one of four factory defaults and the SYSTEM will then initiate a self reset.

### Factory Default Options

#### **Default 1, Local Format (Address 250, enter 1,5,7,8)** (Factory Default for Local SYSTEM)

Local default disables all dialler functions allowing the panel to operate in local mode (sirens and strobe only). Can be very handy as an aid during installation. Whilst in local format, the Pinkerton system can still answer the phone as long as Required Rings (address 168) is not set to zero.

#### **Default 2, Personal Reporting (Address 250, enter 2,5,7,8)** (Factory Default for Dialler SYSTEM)

Personal reporting allows dialler reports to be sent to any telephone including mobile phones. When triggered, the alarm system will immediately seize the line and dial the pre-programmed number. The system will then output an alternating high/low siren type sound to indicate that an alarm has occurred.

#### **Default 3, Domestic Monitored (Address 250, enter 3,5,7,8)**

The domestic monitored default programs the panel for back to base reporting with Open / Close reports disabled.

#### **Default 4, Business Monitored (Address 250, enter 4,5,7,8)**

The business monitored default programs the panel for back to base reporting with all dialler functions enabled.

See the Programming Quick Reference, for a summary of pre-programmed options for the four default types.

**Important:** After address 250 is programmed, all system configurations will revert back to the respective factory default values.

## QUICK START

Your PINKERTON control panel is pre-programmed at the factory and is ready to use immediately. Before attempting to change any of the factory settings check with your customers personal needs.

### PINKERTON factory default settings:

Entry Delay .....	30 seconds
Exit Delay.....	60 seconds
Master Code .....	1234
Zone 1.....	Entry Delay Zone
Zone 2.....	Handover Zone
Zone 3.....	Handover Zone
Zone 4.....	Instant Zone
Zone 5.....	Instant Zone
Zone 6.....	Instant Zone
Zone 7.....	24hr Zone
Zone 8.....	24hr Zone

**Note:** When Armed in Home mode, zones 5 & 6 have been programmed to be isolated.

### INSTALLER CODE & MASTER CODE

Factory default INSTALLER code is

The Installer code can:

- Program all addresses except for address 252
- Review the panel memory

Factory default MASTER code is

The Master code can:

- Turn the panel On and Off
- Program User codes
- Program the telephone numbers (Only when Personal dialling format is selected)
- Program address 252 to restrict the installer code
- Review the panel memory

Note: The Master code can completely disable the Installer code.

See notes on address 252 on page 28.



### HOW TO CHANGE THE MASTER CODE (LOCAL & DIALLER VERSIONS)

At the keypad, enter as follows:

- Press  ..... To clear the keypad
- Press  ..... Current Installer Code
- Press  ..... To enter program mode
- Press  ..... Address for the Master Code
- Press  ..... Your new Master Code
- Press  ..... To exit program mode

### HOW TO CHANGE THE TELEPHONE NUMBERS (DIALLER VERSION)

At the keypad, enter as follows:

- Press  ..... To clear the keypad
- Press  ..... Current Installer Code
- Press  ..... To enter program mode
- Press  ..... Address for the First Telephone Number
- Press  Your new First Telephone Number (Maximum 15 digits)
- Press  ..... Required at the end of each telephone number
- Press  ..... Allows next address to be entered
- Press  ..... Address for the Second Telephone Number
- Press  Your new Second Telephone Number (Maximum 15 digits)
- Press  ..... Required at the end of each telephone number
- Press  ..... To exit program mode

## PROGRAMMING – LOCAL & DIALLER VERSIONS

### BINARY ADDRESSES

Most programming addresses are Yes/No type addresses. The obvious exceptions are TELEPHONE NUMBERS, ACCOUNT NUMBERS, TIMERS, etc, where a value is directly entered rather than selecting yes or no.

Binary Addresses are also called Yes/No options.

When a Yes/No option is selected the state of the 8 options is displayed on the 8 Zone lights.

- The light ON means that the option is turned on.
- The state of each option may be toggled by pressing the relevant digit key from **1** to **8**.
- The **9** key turns ON all options and the **0** key turns OFF all options.
- When the eight options are programmed as required simply press **\*** to allow another 3 digit address to be selected or press **# #** to advance to the next address.
- Pressing **# 0** displays the current address being edited.

#### Example

Programming ZONE OPTIONS for Zone 1

- \*** ..... To clear the keypad
- 2 5 8 0** ..... Factory default Installer Code
- 7** ..... To enter program mode
- 0 7 0** ..... Address for Zone 1 options

The keypad lights will appear as below. At this stage, press any key from 1 to 8 to toggle on or off the relevant option. The factory default settings for Zone 1 are shown in the example below.

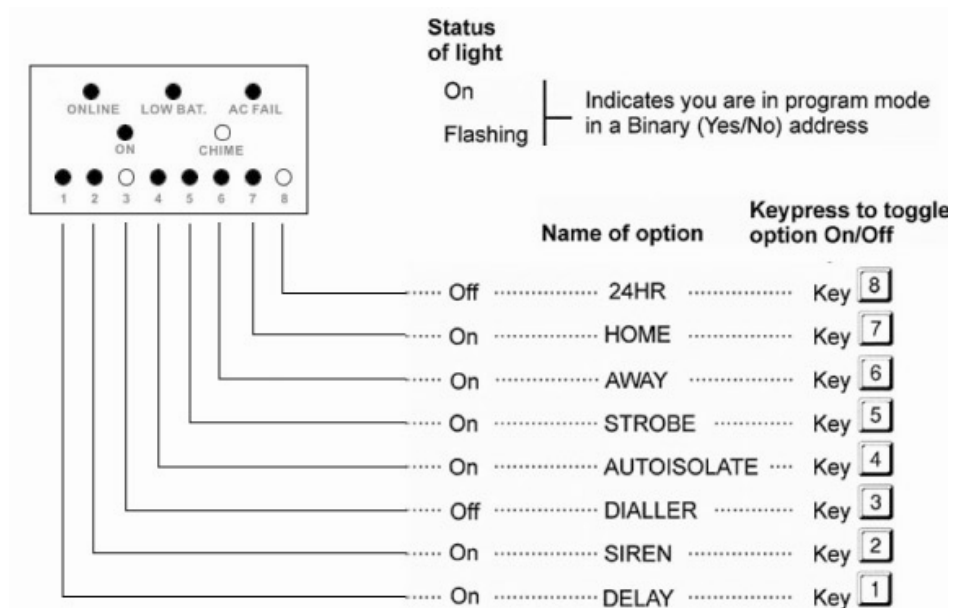

## PINKERTON KEYPAD

### KEYPAD INDICATOR LIGHTS

Listed below are the use of the indicator lights when in normal operation.

Keypad Light	Light ON	Light OFF	Light Flashing
<b>On-Line</b>	Dialler on line	Dialler not on line	Dialler had problems
<b>Low Batt</b>	Battery Charge Voltage Low	Battery OK	Had Low Batt alarm
<b>AC Fail On</b>	Power not connected SYSTEM is on (Away mode)	Power OK SYSTEM is off	Had AC fail alarm SYSTEM is on (Home mode)
<b>Chime</b>	Chime Mode is ON	Chime Mode is OFF	
<b>Zone 1 - 8</b>	Unsealed, Manual or Auto isolated	Zone is sealed	Had alarm

Note that the status of the Zones will always be displayed unless disabled by the installer. The Low Batt and AC Fail lights will show the current state of these inputs, however the alarm (or restore) condition may have to be present for a period before a report is initiated.

If the dialler fails to communicate, the On-Line light will remain flashing until the next time the system is turned off.

All Zone lights on plus a continuous beeper

Means the keypad is locked out for 60 seconds caused by 4 consecutive incorrect code entries.

All Zone lights flashing

Indicates a legal code has been entered (or the  key) and the SYSTEM expects another key to be pressed to select the desired function within 10 seconds.

To cancel simply wait 10 seconds or press the  key.

### KEYPAD BEEPER OPERATION

The keypad beeper will sound under the following circumstances:

Any key press	short beep
Turn SYSTEM OFF	short beep
Turn SYSTEM ON (only heard if exit beep is disabled)	3 short beeps
Display of new data in programming mode	2 short beeps
Wrong key or illegal action	Long beep
Press  key	Long beep
In Home Mode when a Home Beep Zone is triggered	Short beep
Keypad lockout due to too many code entry attempts	Continuous beep
During exit delay if Exit Beep is enabled	Continuous beep
At end of exit delay if Exit Beep is disabled	3 short beeps
During entry delay if Entry Beep is enabled	Continuous beep

## PINKERTON OPERATION

### KEYPAD KEY FUNCTIONS

After a code is entered or the **#** key is pressed, you have 10 seconds to select the operation you wish to perform. During this time all 8 Zone lights will flash to indicate that a key should be pressed. If no key is pressed within 10 seconds, the keypad will revert to idle mode. Enter the code to start again.



The **\*** key is always used as "clear key" to abort the current operation.

### OPERATION OF ALL KEYS

#### PANIC

Key **1**

Enter a User Code followed by **1** or enter **# 1** to trigger the Panic function. The Panic function can trigger the siren, strobe light or dialler as programmed by your installer at address 088.

#### DURESS

Key **2**

Enter a User Code followed by **2** or enter **# 2** to trigger the Duress function. The Duress function can trigger the siren, strobe light or dialler as programmed by your installer at address 086.

#### TEST

Key **3**

Enter a User Code followed by **3** or enter **# 3** to trigger the Test function. The Test function is used to test the dialler by sending a test transmission to the programmed telephone numbers. This function is only available if your system is programmed to report alarms to a monitoring station.

## REVIEW

Key **4**

Enter a user code followed by **4** or simply enter **# 4** to enter review mode. The ON-LINE, LOW BATT, AC FAIL & ON lights will all be on to indicate you are in review mode. Review mode displays a history of past alarms and events stored in the alarm's memory.

This alarm memory is permanently stored and can be cleared by your installer or by pressing the **0** key while in review mode.

(Please note that your entry delay Zone/s will always be stored in memory, even if they have not alarmed.)

While in review mode, various events will be displayed by pressing the following keys:

- Key **1** Displays past Zone alarms since alarm memory last cleared.
- Key **2** Displays past alarms other than Zones.
- Key **3** Display previous events (miscellaneous).
- Key **0** Clear review memories.
- Key **9** Displays the PINKERTON's software version. (in binary).
- Key **\*** Exit review mode.

When first entered, review shows past Zone alarms. The following tables show how to interpret the various displays:

### REVIEW **1**

#### Previous Zone Alarms

While in REVIEW mode, pressing Key **1** displays:

Zone Light	Meaning
1 - 8	Previous alarm on Zones 1 - 8 since system last armed. <i>Note: The first Zone that was triggered will be flashing.</i>

### REVIEW **2**

#### Previous Non-Zone Alarms

While in REVIEW mode, pressing Key **2** displays:

Zone Light	Meaning
1	Duress input triggered.
2	Panic input triggered.
3	Test input triggered.
4	Low Battery input triggered.
5	AC Fail input triggered.
6	On input triggered.
7	Fail-to-communicate input triggered.
8	Spare input triggered.

REVIEW 

Previous Events (Miscellaneous)

While in REVIEW mode, pressing Key  displays:

Zone	Light	Meaning
1		Siren has been turned on.
2		Strobe has been turned on.
3		Dialler has been triggered.
4		Dialler failed (reached max. attempts).
5		(Not used)
6		Maximum code attempts activated.
7		Low battery has turned off siren (and strobe).
8		Answered phone.

**WALK TEST**

Key 

Selecting this operation whilst the alarm system is off will initiate walk-test mode. Walk-test can only be performed by holders of user codes 0 to 7. Walk-test mode allows all Zones and the siren and the strobe to be tested. Operation is as follows:

When walk-test mode is first entered, all 8 Zone lights will be off. The AC Fail light will show whether AC is present or not. The Low Batt light will show whether the battery charging voltage is adequate.

As Zones are triggered the siren will squawk and the relevant Zone light will turn on and remain turned on. This allows a "one man" walk-test by walking through all Zones.

Pressing the  key turns off all Zone lights and allows the test to be repeated, if required.

**SIREN AND STROBE TEST.**

While in test mode:

Pressing the  key will turn on the siren.

Pressing the  key will turn on the strobe.

This enables you to check the individual operation of the siren and strobe. Pressing the  key will turn off the siren and strobe.

Press the  key to exit walk-test.

**Please Note:** *If the siren and strobe are being tested in the Mode and activation of a zone will deactivate their respective output.*

**ISOLATE**

Key **6**

This operation allows Zones 1 - 8 to be manually isolated or re-enabled at any time and is only available to holders of user codes 0 to 7. The ON-LINE, LOW BATT, AC FAIL and ON lights will illuminate and the Zone lights will show the current manual isolate status of the Zones.

A Zone light being ON, means that Zone is manually isolated.

As keys **1** to **8** are pressed, the relevant Zone light will toggle on or off. When the light is on the Zone is isolated.

The **\*** key is used to exit out of isolate mode (isolate mode will also end if there are no keys pressed for 10 seconds).

Note that isolated Zones only remain isolated until the next time the alarm system is turned off, even if the alarm system is already off. AC fail, Low battery, Panic, Test and Duress inputs cannot be isolated.

**PROGRAM**

Key **7**

Enter installer or master code followed by **7** to enter programming mode. Only available to the master code and the installer code.

**ON (HOME MODE)**

Key **8**

Enter any user code followed by **8** or enter **# 8** to turn the system on in Home Mode. ON light will flash to indicate system is armed in home mode. Only Zones which are programmed as Home Zones will be active.

**ON (AWAY MODE)**

Key **9**

Enter **\*** followed by any user code followed by **9** or enter **# 9** to turn the system on in Away Mode. ON light will turn on to indicate alarm system is armed in Away Mode. Only Zones which are programmed as Away Zones will be active. All user codes are allowed to arm the alarm system.

If Power Codes are enabled, (address 096, option 7), then codes 8 - 15 do not need to use **9** to turn ON).

**OFF (DISARM)**

Key **0**

Enter **\*** followed by any code followed by **0** to turn the Pinkerton alarm OFF. Turning the alarm OFF will also turn the sirens and strobe off and re-enable manually isolated Zones even if the alarm system is already off.

If Power Codes are enabled, (address 096, option 7), then codes 8 - 15 do not need to use **0** to turn OFF).

**CHIME MODE ON**

This mode enables the selected zone to chime/beep when activated. This is useful for door entry applications.

To turn on chime mode, press and hold the zone number until a confirmation beep is heard. For example:

Press and hold **1**.....To turn ON chime mode for zone 1.

Press and hold **2**.....To turn ON chime mode for zone 2.

Press and hold **3**.....To turn ON chime mode for zone 3.

Press and hold **4**.....To turn ON chime mode for zone 4. etc.

Zones 1 to 8 can be in chime mode. All or multiple zones can be in chime mode. Chime LED on the keypad will be lit to indicate chime mode is active.

**CHIME MODE OFF**

To turn off chime mode,

Press and hold **0**.....To turn OFF chime mode.



## SIREN OUTPUT

### TURNING SIREN ON.

Any active input can be programmed to trigger the siren. When in Home Mode, there is a separate option for enabling sirens for any Zone, see: **Zone Options Section 2**.

Note that Zones with the siren lockout option set for that Zone can only trigger the siren once during any one armed period. Note that panic, test and duress key sequences simply trigger the respective inputs and will only sound the siren if the siren is enabled for those inputs.

If address 240, option 7 is on, the siren can be toggled on and off by triggering Zone 7. See page 26.

### TURNING SIREN OFF.

- Siren will turn off at the end of siren time; which is set by address 104. Siren time can be set between 01 and 99 minutes and is accurate to about 1 second/minute.
- Siren can be toggled off by triggering Zone 7 only if it was turned on by Zone 7. If an alarm Zone turned the siren on, Zone 7 will not turn the siren off. This is valid only if address 240, option 7 is on.
- Siren will turn off if low battery is sensed. If low battery is sensed at any time, the strobe and siren will be turned off if they are on. This reserves battery power for the dialler.
- Siren will turn off when a valid user code turns the panel off.

If Fail To Communicate (address 066) is programmed to sound the siren, it will only sound the siren when the dialler has made the programmed number of attempts to communicate. If an open or close report fails to communicate, the siren will not be triggered.

## STROBE OUTPUT

### TURNING STROBE ON:

Any active input can be programmed to trigger the strobe. When in Home Mode there is a separate option for enabling the strobe for any Zone, **see: Zone Options Section 2**.

Note that panic, test and duress key sequences simply trigger the respective inputs and will only trigger the strobe if the strobe is enabled for those inputs.

### TURNING STROBE OFF:

- Strobe will turn off when a valid user code turns the panel off.
- By low battery being sensed. If low battery is sensed while the strobe is on, it will be turned off immediately. The siren will also be turned off if it is on. This reserves battery power for the dialler.

**KEY FUNCTIONS IN PROGRAM MODE**

The table below summarises the use of all keys once a legal address has been entered:

<b>Key</b>	<b>Operation</b>
<input type="button" value="*"/>	Back to start of program mode waiting for 3 address digits.
<input type="button" value="*"/> <input type="button" value="*"/>	Exit programming operation - back to idle.
<input type="button" value="0"/>	Used to enter decimal data, in Yes/No mode sets all options to off.
<input type="button" value="1"/> to <input type="button" value="8"/>	Used to enter decimal or Yes/No data.
<input type="button" value="9"/>	Used to enter decimal data, in Yes/No mode turns all options on.
<input type="button" value="#"/> <input type="button" value="1"/> to <input type="button" value="#"/> <input type="button" value="6"/>	Used to enter 10,11,12,13,14 or 15 for decimal options only. For example: # 6 is used to make codes non-operational and sets the end of phone numbers. # 5 is used to put a pause in a telephone number.
<input type="button" value="#"/> <input type="button" value="0"/>	Momentarily display current address.
<input type="button" value="#"/> <input type="button" value="7"/>	Illegal
<input type="button" value="#"/> <input type="button" value="8"/>	Illegal
<input type="button" value="#"/> <input type="button" value="9"/>	Illegal
<input type="button" value="#"/> <input type="button" value="#"/>	Increment current address
<input type="button" value="#"/> <input type="button" value="*"/>	Illegal

**Operation Of Non-Zone Lights In Program Mode**

ON-LINE	LOW BATT	AC FAIL	ON	MEANING
FLASHING	OFF	OFF	OFF	Waiting for the first digit of an address
FLASHING	FLASHING	OFF	OFF	Waiting for the second digit of address
FLASHING	FLASHING	FLASHING	OFF	Waiting for the third digit of an address
ON	ON	ON	ON	Displaying Decimal data
ON	ON	ON	FLASHING	Displaying Binary data

When all three digits of each address have been entered, the Zone lights will display data in one of two ways depending on the type of option, decimal or Yes/No. Note that the On light shows whether the option is Decimal or Yes/No.

**PROGRAMMING TIPS:**

1. When in program mode, all inputs are disabled. For service purposes, this allows the installer to open the Pinkerton alarm cabinet and power down the system without causing an alarm.
2. The Pinkerton system will not remain in program mode indefinitely. For security purposes, the system will drop out of program idle mode if two minutes elapse without a key press. When in address mode, the system will drop back to program idle mode if no keys are pressed within ten seconds.
3. The following addresses require a Reset to take effect. (See page 28, address 254, for further information on panel reset).

Addresses 096, 098, 168, 170, 174, 240

**ADDRESS DESCRIPTIONS – USER CODES**

Name of option	Address	Value allowed	Option Description
User 0 Master Code	000	4 digits	The Master code can turn the alarm ON and OFF and change user codes and the temporary telephone number as well as functions at address 252.
User 1 Installer Code	004	4 digits	The Installer code has access to all functions(except arming and disarming) and addresses except address 252. The Installer code can be disabled by the Master code at address 252.
User 2	008	4 digits	Has access to all functions except programming
User 3	012	4 digits	Has access to all functions except programming
User 4	016	4 digits	Has access to all functions except programming
User 5	020	4 digits	Has access to all functions except programming
User 6	024	4 digits	Has access to all functions except programming
User 7	028	4 digits	Has access to all functions except programming
User 8	032	4 digits	Can only turn the system ON and OFF
User 9	036	4 digits	Can only turn the system ON and OFF
User 10	040	4 digits	Can only turn the system ON and OFF
User 11	044	4 digits	Can only turn the system ON and OFF
User 12	048	4 digits	Can only turn the system ON and OFF
User 13	052	4 digits	Can only turn the system ON and OFF
User 14	056	4 digits	Can only turn the system ON and OFF
Usr 15	060	4 digits	Can only turn the system ON and OFF

- To erase a code, enter   in place of the first digit.
- See address 096, option 7 for information on the use of user codes 2 - 15 as Power Codes.

	Master		Installer													
	0	1	2	3	4	5	6	7	8	9	10	11	12	13	14	15
Turn ON/OFF Home mode and Away mode	Y		Y	Y	Y	Y	Y	Y	Y	Y	Y	Y	Y	Y	Y	Y
Keypad Panic	Y	Y	Y <sup>1</sup>	Y <sup>1</sup>	Y <sup>1</sup>	Y <sup>1</sup>	Y <sup>1</sup>	Y <sup>1</sup>	Y <sup>1</sup>	Y <sup>1</sup>	Y <sup>1</sup>	Y <sup>1</sup>	Y <sup>1</sup>	Y <sup>1</sup>	Y <sup>1</sup>	Y <sup>1</sup>
Keypad Duress	Y	Y	Y <sup>1</sup>	Y <sup>1</sup>	Y <sup>1</sup>	Y <sup>1</sup>	Y <sup>1</sup>	Y <sup>1</sup>	Y <sup>1</sup>	Y <sup>1</sup>	Y <sup>1</sup>	Y <sup>1</sup>	Y <sup>1</sup>	Y <sup>1</sup>	Y <sup>1</sup>	Y <sup>1</sup>
Keypad Test	Y	Y	Y <sup>1</sup>	Y <sup>1</sup>	Y <sup>1</sup>	Y <sup>1</sup>	Y <sup>1</sup>	Y <sup>1</sup>	Y <sup>1</sup>	Y <sup>1</sup>	Y <sup>1</sup>	Y <sup>1</sup>	Y <sup>1</sup>	Y <sup>1</sup>	Y <sup>1</sup>	Y <sup>1</sup>
Isolate zones	Y	Y	Y	Y	Y	Y	Y	Y								
Review memory	Y	Y	Y	Y	Y	Y	Y	Y								
Program User codes	Y	Y														
Program Temporary telephone number	Y	Y														
Program system addresses		Y														
Program address 252	Y															
Program address 255	Y	Y														
Panel reset	Y	Y														
Remote access by telephone	Y		Y	Y	Y	Y	Y	Y	Y	Y	Y	Y	Y	Y	Y	Y
Remote access by PSA-Connect		Y														

<sup>1</sup> If Powercodes are enabled, Codes 2-15 do not have access to Panic, Duress, Test functions at the keypad.



## CHANGING ZONE CONFIGURATIONS

The default settings for your PINKERTON system are:

- |                           |                       |
|---------------------------|-----------------------|
| <b>Zone 1</b> Entry Delay | <b>Zone 5</b> Instant |
| <b>Zone 2</b> Handover    | <b>Zone 6</b> Instant |
| <b>Zone 3</b> Handover    | <b>Zone 7</b> 24 Hour |
| <b>Zone 4</b> Instant     | <b>Zone 8</b> 24 Hour |

Should you wish to change these settings follow the instructions below. Generally there are four types of zone settings. Each Zone has 2 sections to program, Section 1 and Section 2.

- These are indicated using the keypad lights.
- Refer to Address Descriptions on page 21 and 22 for keypad light indication.

### Section 1.

#### Entry Delay

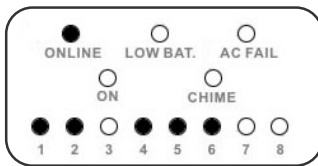

#### Handover

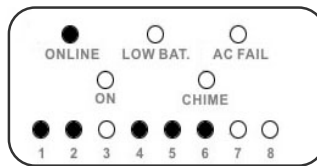

#### Instant

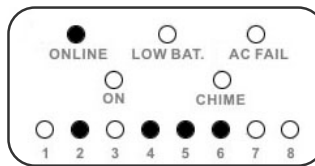

#### 24 Hour

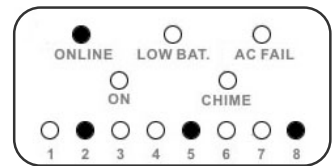

### Section 2.

#### Entry Delay

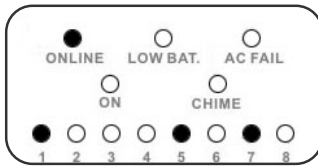

#### Handover

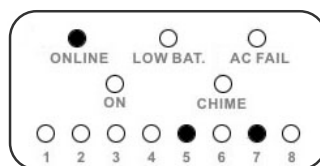
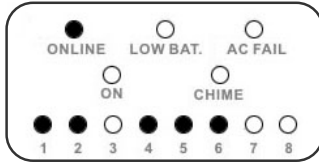

TABLE	SECTION 1	SECTION 2
Zone One	070	224
Zone Two	072	226
Zone Three	074	228
Zone Four	076	230
Zone Five	078	232
Zone Six	080	234
Zone Seven	082	236
Zone Eight	084	238

## CHANGING ZONE CONFIGURATIONS

### Example – Programming Zone 1 for Entry Delay

#### Section 1.



#### Section 2.

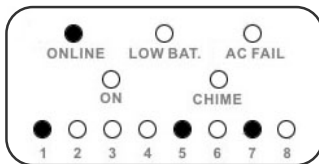

1. Enter Installer Code **2580**
  2. Press the **7** key (The On-Line light will now flash).
  3. Enter **070** (Section 1 three digit address).
  4. Pressing each number on the keypad will turn the respective Zone LED on or off. Proceed to press each Zone number so the diagram to the left (Section One) represents the keypad.
  5. Having completed step 4 press the **\*** key once. This will allow you to enter the three digit address for Section 2 (224).
  6. Enter **224** (Section 2 three digit address).
  7. Pressing each number on the keypad will turn the respective Zone LED on or off. Proceed to press each Zone number so the diagram to the left (Section Two) represents the keypad.
  8. Enter **\* \*** to cancel the programming mode.
- To program zones 2 – 8 follow the same procedure as above using the Section 1 and Section 2 table on the previous page.

## ADDRESS DESCRIPTIONS – LOCAL &amp; DIALLER VERSIONS

Name of option	Address	Value allowed	Option Description
<b>Zone Option Section 1 &amp; System Inputs</b>		Select 1 - 8	
Zone 1	070		<p>1 Handover Zones selected for handover have entry delay as long as a delayed Entry Delay Zone has been triggered first (see next page). If a Handover Zone is triggered before an Entry Delay Zone, the alarm will be instant. Note that delay will be ignored if selected for 24 hour inputs. In home mode, there will be no delay if the Home Instant option is set (address 098, option 7).</p> <p>If during entry delay an instant alarm occurs, this will be actioned immediately without affecting the delayed inputs operation.</p> <p>If the system is turned ON in Home Mode and Home Instant (address 098, option 7) has been enabled, then all delayed inputs will be instant while the panel is in Home Mode. All 24 hour inputs are treated as instant even if they have been programmed for Handover or Entry Delay.</p> <p>At the end of the entry delay, all delayed inputs that were triggered will go into alarm unless the panel has been turned OFF before the end of the entry delay.</p>
Zone 2	072		
Zone 3	074		
Zone 4	076		
Zone 5	078		
Zone 6	080		
Zone 7	082		
Zone 8	084		
Open/Close	064		2 Siren Any active input can be programmed to trigger the siren. When in Home Mode, there is a separate option for enabling sirens for any Zone, see: Zone Options Section 2.
Fail to Comm	066		
Duress Input	086		
Panic Input	088		3 Dialler Zones selected for dialler will trigger the dialler when alarmed. If a Zone is triggered in Home Mode, it will only trigger the dialler if the Home Report option is on. Selecting Dialler for the Fail to Communicate input will be ignored.
Test Input	090		
Low Battery	092		
AC Fail	094		4 Autoisolate Zones selected for auto-Isolate will be isolated if still unsealed at the end of exit delay. Generally speaking the Auto Isolate option is not programmed for 24 hour inputs
			5 Strobe Any active input can be programmed to trigger the strobe. When in Home Mode, there is a separate option for enabling strobe for any Zone, see: Zone Options Section 2.
			6 Away Zones selected for Away will be armed at the end of exit delay when panel is turned on in Away mode.
			7 Home Zones selected for Home will be armed at the end of exit delay when panel is turned on in Home mode.
			8 24hr Zones selected as 24hr will be permanently armed. <b>Note:</b> The system must be reset for this change to take effect.

Name of option	Address	Value allowed	Option Description
Zone Option Section 2		Select 1 - 8	<p>1 Entry Delay Setting this option will cause this Zone to be an Entry Delay Zone. At least one Zone must be made an Entry Delay Zone for entry delay to operate. Once the entry timer has started any further inputs triggered that are programmed as Handover Zones are also regarded as delayed although the entry timer is not re-started.</p>
Zone 1	224		
Zone 2	226		
Zone 3	228		
Zone 4	230		<p>2 Home beep Setting this option will cause this Zone to sound the keypad beeper in home mode when triggered. If the Home Squawk option (address 098, option 5) is also on, then the siren will also squawk momentarily in home mode when this home Zone is triggered.</p>
Zone 5	232		
Zone 6	234		
Zone 7	236		<p>3 Siren lockout Setting this option will cause any Zone to trigger sirens once only. Note that the dialler may still be re-triggered as long as the Report Lockout option is off.</p>
Zone 8	238		
			<p>4 Report lockout Setting this option will cause this Zone to report only one alarm even if triggered more than once. A Zone isolate will also be sent if programmed by the Send Isolated Zone Reports option (address 170, option 8). This is independent of the Siren Lockout option.</p>
			<p>5 Home siren Setting this option will cause this Zone to sound the siren in home mode when triggered. <b>Note:</b> If disabled then this Zone will never sound the siren in home mode.</p>
			<p>6 Home report Setting this option will cause this Zone to trigger the dialler in home mode when alarmed. <b>Note:</b> If disabled then this Zone will never trigger the dialler in home mode.</p>
			<p>7 Home strobe Setting this option will cause this Zone to turn on the strobe in home mode when alarmed. <b>Note:</b> If disabled then this Zone will never turn on the strobe in home mode.</p>
			<p>8 Pulse Zone Pulse count operation applies to Zones 1 to 8. The Zones may be delayed or instant. Operation is as follows: When the first Zone with the Pulse Zone option set is triggered, a pulse timer is started. The pulse timer expires in the time set at address 244. If the programmed number of triggers are processed from any pulse count Zone within the pulse count time, all the triggered pulse count Zones will then go into alarm. If the pulse timer expires before that required number of pulse triggers has occurred, then all pulse triggers to that point are ignored. This feature enables false alarms to be reduced by specifying at least 2 triggers from a Zone(s) before considering an alarm condition to exist.</p>

Name of option	Address	Value allowed	Option Description
Panel Options 1	096	Select 1 - 7	<p>1 Display lights If this option is turned off, the keypad will not display Zone lights. On-Line, Low Batt, AC Fail and On will still display.</p> <p>2 Quick Away Allows the use of <input type="button" value="#"/> <input type="button" value="9"/> to turn the panel on to Away Mode.</p> <p>3 Quick Home Allows the use of <input type="button" value="#"/> <input type="button" value="8"/> to turn the panel on to Home Mode.</p> <p>4 Code 15 once Allows user code 15 to only turn the panel off once only. As soon as the code is used, it is automatically erased. Handy as a single use code to be handed out to temporary staff or cleaners etc.</p> <p>5 AC Fail delay Normally AC Fail is immediately reported (if programmed to do so) as soon as AC power is interrupted. When AC Fail delay is selected, the panel does not report power failure unless power is interrupted for longer than 30 minutes. Note that in idle mode the keypad lights display the current state of this input with no delay.</p> <p>6 Quick review Allows the use of <input type="button" value="#"/> <input type="button" value="4"/> to review the panel memory (previous alarms etc, see page 13).</p> <p>7 Power Codes Allows user codes 2 – 15 to turn the system ON and OFF without the use of the <input type="button" value="0"/> or <input type="button" value="9"/> keys.</p> <p>8 Not used</p>



Name of option	Address	Value allowed	Option Description
Panel Options 2	098	Select 1 - 8	<p>1 Exit beep If this option is turned on, the keypad beeper will sound continuously during exit delay. If any key is pressed during exit delay, the beeper will stop sounding. If this option is turned off, the system will not beep continuously during exit delay but will give three beeps at the end of exit delay.</p> <p>2 Entry beep If this option is turned on, the keypad beeper will sound continuously during entry delay. If any key is pressed during entry delay, the beeper will stop sounding.</p> <p>3 Exit squawk If this option is turned on, the siren output will squawk momentarily at the end of exit delay. The duration of the squawk is set by address 110.</p> <p>4 Entry squawk If this option is turned on, the siren output will squawk momentarily at the start of entry delay. The duration of the squawk is set by address 110.</p> <p>5 Home squawk If this option is turned on, the siren output will squawk momentarily every time a Home Beep Zone is triggered in Home mode. The duration of the squawk is set by address 110.</p> <p>6 ON/OFF squawk or flash If this option is turned on, the siren output will squawk or the strobe output will flash when the system is turned ON and OFF using the KY keyswitch input.</p> <p>7 Home instant If this option is turned on, all Zones in Home mode will be instant even if programmed for delay. This does not affect delay timers in Away mode.</p> <p>8 No Quick Arming if low battery If this option is turned on, the panel will check the state of the battery charging voltage prior to turning the system ON with the quick arm sequence <input type="text" value="#"/> <input type="text" value="9"/> and if the battery is low will not allow the panel to be turn on. The system can always be turned on with a code.</p>

Name of option	Address	Value allowed	Option Description
Entry delay	100	00 - 165 seconds	Sets the entry delay time. Applies to Entry Delay and Handover Zones.
Exit delay	102	00 - 165 seconds	Sets the exit delay time. Applies to all Zones except 24hr Zones.
Siren time	104	00 - 165 minutes	Sets the duration for the Siren output.
Test time	106	00 - 165 hours	Sets the time between test reports.
Test report delay	246	00 - 165 hours	Sets the time by which the first test report will be delayed. This delay commences from the first system reset after power-up. See page 36, Automatic Test Reports.
Trim time	108	00 - 165 minutes	Reduces the time between test reports to adjust test report time accuracy.
Squawk time	110	00 - 165 milliseconds	Sets the siren squawk duration. (Note, ON/OFF squawks are of fixed length).
See page 24 for further information on siren squawks.			

Name of option	Address	Value allowed	Option Description																					
General options	240	Select 1, 4, 6, 7	<p>1 Enable external inputs. Enables the three additional inputs on the expansion pins on the Pinkerton main board. These inputs are labelled Panic, Duress and Test and are treated as normal Zone inputs when enabled - resistors are required. Note that no restoral reports are sent by these three inputs.</p> <p>2 &amp; 3 Zone Input Sensitivity The response time of the Zone inputs can be increased to allow the use of vibration sensors on one or more Zone inputs. Turn lights 2 and 3 on or off to adjust for high, medium or low sensitivity. Note that the setting will apply to all Zone inputs.</p> <table border="0"> <tr> <td><b><u>Input sensitivity</u></b></td> <td><b><u>Light 2</u></b></td> <td><b><u>Light 3</u></b></td> </tr> <tr> <td>Normal (default)</td> <td>OFF</td> <td>OFF</td> </tr> <tr> <td>High</td> <td>ON</td> <td>OFF</td> </tr> <tr> <td>Medium</td> <td>OFF</td> <td>ON</td> </tr> <tr> <td>Low</td> <td>ON</td> <td>ON</td> </tr> </table> <p>4 Squawk or Flash. Sets the option for either audible or visual indication of the ON/OFF state of the system.</p> <table border="0"> <tr> <td></td> <td><b><u>Light 4</u></b></td> </tr> <tr> <td>Strobe flash</td> <td>On</td> </tr> <tr> <td>Siren squawk</td> <td>Off</td> </tr> </table> <p>Address 098, option 6 must also be on for siren squawk and strobe flash to work.</p> <p>5 not used</p> <p>6 Zone 8 home key. When selected, Zone 8 is used to turn the system ON in home mode.</p> <p>7 SIREN TOGGLE When selected, this option will cause any activation of Zone 7 to toggle the siren ON and OFF. Note that if the siren was triggered by an alarm condition, Zone 7 will not toggle the siren OFF.</p> <p>8 not used</p>	<b><u>Input sensitivity</u></b>	<b><u>Light 2</u></b>	<b><u>Light 3</u></b>	Normal (default)	OFF	OFF	High	ON	OFF	Medium	OFF	ON	Low	ON	ON		<b><u>Light 4</u></b>	Strobe flash	On	Siren squawk	Off
<b><u>Input sensitivity</u></b>	<b><u>Light 2</u></b>	<b><u>Light 3</u></b>																						
Normal (default)	OFF	OFF																						
High	ON	OFF																						
Medium	OFF	ON																						
Low	ON	ON																						
	<b><u>Light 4</u></b>																							
Strobe flash	On																							
Siren squawk	Off																							
Attempts before fail to communicate	242	00 - 10 attempts	Sets the number of unsuccessful dialling attempts the system will make before triggering Fail to Communicate. (Actions triggered by Fail to Communicate are set at address 066).																					
Zone pulse count	243	00 - 99 counts	Sets the number of Pulse Zones which may be triggered before generating an alarm condition.																					
Zone pulse time	244	00-165 seconds	Sets the time during which the system will count triggers from Pulse Count Zones.																					

Name of option	Address	Value allowed	Option Description
Factory defaults	250	1,5,7,8 2,5,7,8 3,5,7,8 4,5,7,8	At this address, enter: 1,5,7,8 Local default - dialler disabled ( <b>local factory default</b> ) 2,5,7,8 Personal reporting to private phone or mobile phone ( <b>dialler factory default</b> ) 3,5,7,8 Domestic monitored (without open/close reports) 4,5,7,8 Business monitored (all dialler options enabled)

Special functions for Master Code	252	Select 1, 2, 3	<p>1 No installer. Setting this option will completely disable the installer code. Note, this applies to PINKERTON V18 onwards. In previous versions, this option only prevents the installer code from programming the PINKERTON system.</p> <p>2 No computer access. Setting this option will prevent the system from communicating with PSA Connect remote access software.</p> <p>3 No telephone arming. Setting this option will prevent the system from being turned ON or OFF using a remote telephone. The system will still answer the telephone (if the option is set) and announce it's ON/OFF status.</p>
-----------------------------------	-----	----------------	---

Panel reset	254	When in programming mode, enter 254. Accessing the address performs the panel reset.	<p>This option is available to the Installer code and the Master code. Panel reset is the same as "booting" your computer. No data or programming is lost. Simply, the microprocessor is re-started.</p> <p>Panel reset is required after programming for some functions to work correctly. For example, do a reset after programming test reports to initialise the first test report. As a rule. It is good practise to reset the panel when you have finished programming the system.</p> <p><b>HANDY HINT:</b> After a reset, if you dial into the system within 60 seconds, it will answer the telephone after 2 rings instead of the programmed number of rings. This is a handy way of quickly accessing the system with PSA Connect software or by remote telephone.</p>
-------------	-----	---	--

Special function for Installer Code	255	Enter 9	<p>This option is only available to the Installer code. Setting this option to "9" will prevent the system from being defaulted in any way including initialising of the Installer code with the "KY power up" .</p> <p><b>WARNING:</b> WHEN THIS OPTION IS SET THE INSTALLER CODE CAN NEVER BE RECOVERED. IF YOU FORGET YOUR INSTALLER CODE, THE SYSTEM MUST BE RETURNED FOR SERVICE.</p>
-------------------------------------	-----	---------	--

## NON-ZONE INPUTS

### OPEN / CLOSE INPUT (Address 064)

The "Open/Close" input is designed to send opening and closing reports to the monitoring station when the panel is turned on and off. If enabling, select Dialler and 24hr options only.

### FAIL TO COMMUNICATE INPUT (Address 066)

The Fail to Communicate input is intended to trigger the sirens and strobes if the dialler fails to establish contact with the monitoring station after the number of attempts set by address 242.

### DURESS, PANIC & TEST INPUTS

The DURESS, PANIC and TEST functions are all physical inputs to the Panel. As with Zone inputs, they can be triggered by connecting a switch of some kind directly to the panel. These physical inputs are in addition to the eight alarm Zones: They are accessed by three terminals on the Panel PCB and, like the Zone inputs, require 4.7K resistors to be fitted if used.

NOTE: Duress, Panic and Test are simply labels assigned by the Ademco High Speed reporting format. Duress, Panic or Test buttons can be connected to any of the eight Zone inputs and will perform in a similar manner.

### DURESS INPUT (Address 086)

The Duress terminal on the panel PCB is programmed the same as any Zone input. The Duress function is also available as a keypad function if the input is first enabled.

### PANIC INPUT (Address 088)

The Panic terminal on the panel PCB is programmed the same as any Zone input. The Panic function is also available as a keypad function if the input is first enabled.

### TEST INPUT (Address 090)

The Test terminal on the panel PCB is programmed the same as any Zone input. The Test function is also available as a keypad function if the input is first enabled.

### LOW BATTERY (Address 092)

This input transmits low battery when the battery voltage is below 11.5 volts. Normally programmed to trigger the dialler only.

### AC FAIL (Address 094)

This input is normally programmed to trigger the dialler only.



**Programming Section for Dialler Panels.**

## PROGRAMMING – DIALLER VERSION

### DECIMAL ADDRESSES

#### OVERVIEW

Decimal options are selected by their start address. For example the primary telephone number is selected by address 128. When a decimal option is first selected, all digits of the option are displayed in sequence in the same manner as the display address option. If displaying a telephone number then the display terminates if it encounters a "15". (end of telephone number).

#### DISPLAYING DIGITS

While displaying the digits, (each digit for 1.5 secs) the ON-LINE, BATT, POWER and ON lights will turn on sequentially, one at a time as each new digit of the option is displayed. (If the decimal option is only a single digit option the "sequential display" is skipped). If any key is entered whilst displaying decimal data, the rest of the display sequence is skipped.

#### ENTERING DIGITS

Once all the digits are displayed, all Zone lights will momentarily light and the display will revert to normal entry mode, starting at the start address of the selected decimal option. New data may now be entered by simply typing the required digits. Each digit entered can range from 0 to 15. As each digit is entered it will momentarily be displayed before advancing to the next address and displaying its contents.

Enter   to show what address you are up to.

Enter   to advance to the next address.

When the required number of digits (or   ) has been entered, the system will revert back to address entry mode.

### Technical Note

If installing a dialler panel and the telephone line is not being connected, you must default the panel to local format. If the panel is not defaulted you may experience difficulties disarming the panel when in alarm. This is due to the alarm panel attempting to detect the telephone line. As a result, the keypad will not accept any codes. This situation can be rectified by connecting a telephone line or default for local.

### PROGRAMMING TIP:

When you access any decimal address, the existing data will be displayed first as described above. It is not necessary to wait for the display to finish. The data display can be interrupted by pressing the  key or simply by entering the new data.

Use of the  key for decimal addresses

**1. Programming values greater than 99**

- For programming any TIMERS up to a total value of 165. (Entry delay, Exit delay etc.)

**2. When programming telephone numbers**

- Must be used when programming TELEPHONE NUMBERS (Enter #6 at the end of the number.)
- Is used to enter a pause between digits of a TELEPHONE NUMBER (#5 gives a 2 second pause.)

Key Press	Value stored	Indicated by Zone light
0	0	None
1	1	1
2	2	2
3	3	3
4	4	4
5	5	5
6	6	6
7	7	7
8	8	8
9	9	1 + 8
# 1	10	2 + 8
# 2	11	3 + 8
# 3	12	4 + 8
# 4	13	5 + 8
# 5	14	6 + 8
# 6	15	7 + 8

**EXAMPLE - PROGRAMMING VALUES GREATER THAN 99**

To program entry delay for 155 seconds, enter #65 at address 100.

How It Works

The #6 puts a value of 15 in the first bit of the address.

The 5 puts of value of 5 in the second bit of the address.

The first bit is internally multiplied by 10, which gives .. 150 seconds

The second bit is not multiplied ..... 5 seconds

Total = 155 second



## DIALLER FUNCTIONS

### PERSONAL REPORTING

Personal reporting allows dialler reports to be sent to a person rather than a central station if an alarm occurs. When an alarm occurs, the system will immediately seize the line and dial a pre-programmed number. The system will then output an alternating high/low siren type sound to indicate that an alarm has occurred.

If Send Zone ID (address 170, option 6) is set then the system will output a series of beeps, the number of beeps equal to the Zone number that was triggered.

Every 10 seconds the tones will pause, allowing any key to be pushed to acknowledge the call and cause the system to announce the current state of the panel, 1 beep for off, 2 beeps for on. Pressing

 may now be used to hang-up the system immediately or it will hang-up anyway after 15 seconds. During this time the system can be turned on or off.

If after one minute no key has been pressed, the system will hang up and try again. See page 35, section on Operation of Telephone Numbers for retry logic.

During reporting in personal format mode, prior to a key being pushed by the answering party, the report may be aborted by entering any valid code on the PINKERTON keypad. Note that once the called party has pushed a key, the PINKERTON keypad lights will flash indicating that the called party is in control.

A special temporary telephone number can be programmed by the master code to replace the primary telephone number. When programmed, this number will replace the primary telephone number until the panel is next turned off from away mode, at which time the first digit of the temporary number is erased (disabling the temporary number) and operation will revert to the primary telephone number.

**ADDRESS DESCRIPTIONS – DIALLER VERSION**

Temporary Phone No*	112	15 digits max.	When Personal dialling is selected, the temporary number will be used instead of the primary number.
Phone No 1*	128	15 digits max.	All telephone calls will be sent to Telephone Number 1 first. (In the Personal dialling <sup>1</sup> , Telephone number 1 is ignored if the Temporary telephone number is programmed.
Phone No 2*	144	15 digits max.	If the second telephone number is programmed, then after every 2 calls to the primary number, 2 calls will be tried to the second number. Whenever the second telephone number is used, the second account number will be used if programmed.
* Telephone numbers must end with <input type="text" value="#"/> <input type="text" value="6"/> to be valid			
<sup>1</sup> See page 32 for further information on Personal dialling			
Account No 1	160	4 digits	Monitoring station account number.
Account No 2	164	4 digits	Monitoring station account number.
Required rings	168	00 - 99 rings	Sets the number of rings before the panel will answer the phone. If set to 00, the panel will never answer the phone. Enable fax bypass by setting required rings to 99. Fax bypass is designed to allow remote connection to the panel when it is sharing a telephone line with a fax machine or answering machine. Ring the panel once and hang up. Ring back immediately, the panel will then answer on the first ring.

Name of option	Address	Value allowed	Option Description
Dialler options	170	Select 1, 2, 6, 7, 8	<p>1 Rotary Dial. The system is factory programmed for tone dialling. Select this option to enable rotary (decadic) dialling.</p> <p>2 Open after alarm. When this option is selected, the system will send an opening report only if Zone alarms have occurred during the last armed period. This reduces the number of telephone calls made but allows the central station to be informed when an authorised access is taking place after an alarm has occurred. To use the open after Zone alarm facility: Enable Open After Alarm at address 170, option 2. Disable all options at address 064 except for option 8. Note that when the Open After Alarm option is set, the central station will never receive a closing report.</p> <p>3 not used</p> <p>4 not used</p> <p>5 not used</p> <p>6 Send Zone ID (Personal dialling) Option ON: The called phone hears a number of beeps equal to the Zone number which triggered the alarm. Option OFF: The called phone hears a high/low siren tone.</p> <p>7 Send restoral reports When selected, the system will send a restoral report to the monitoring station when the alarmed input has resealed.</p> <p>8 Send isolated Zone reports When selected, the system will send isolated Zone reports to the monitoring station along with the closing report when the system is turned on.</p>
Dialler format	174	Select 0, 1, 3, 4	<p>0 Disables dialler (handy installer option for temporary or permanent disabling of dialler)</p> <p>1 Ademco high speed with checksum</p> <p>2 not used</p> <p>3 Contact ID</p> <p>4 Personal dialling</p>
Maximum dialling attempts	175	00 - 10 attempts	Sets the maximum number of attempts the dialler will make when triggered. Factory default is 6 attempts. Do not set to over 10 attempts.



## REMOTE ACCESS BY TELEPHONE

The system can be called for the following purposes:



- By any person to see if the system is ON or OFF.
- By a master or user code holder, to turn the system ON or OFF.
- By a computer using “PSA-Connect” software and a PSA-Connect modem.

All user codes apart from the installer code are allowed remote access by ringing into the Pinkerton system.

When on line to the panel, the following telephone keys may be used:

- |   |   |
|---|---|
|   key | Hangup  |
|  key   | Clear key (and annunciate system status and “stay on line” command) |
| 0 – 9   | Used to enter a digit of a code                                     |

Before entering a legal code you must enter the  key, after entering a code the system will wait an additional 3 seconds for a fifth key to be pressed. Allowable keys are:

- |  |                                      |
|--|--------------------------------------|
|  0  | Turn panel off if it is on.          |
|  9 | Turn panel to away mode if it is off |

If no code entry occurs for 15 seconds, the system will hangup. Note that normal dialler operation will be suspended until the system hangs up.

Note that when first powered up or reset (address 254), the system will answer the phone on the first ring for the next 60 seconds as long as Required Rings (address 168) is not set to zero.

Operation of second telephone number and fail to communicate

When sending reports to a Central Station the system will make the number of attempts, set in address 175, to communicate the information. If the number of attempts is set to 6 or more then the system will be able to use its anti-jam logic to attempt to clear a jammed line. Austel specify that dial attempts should not exceed 10. The time between calls will vary according to the anti-jam logic. If the second telephone number is programmed, then after every 2 calls to the primary number, 2 calls will be tried to the second number. Whenever the second telephone number is used, the second account number will be used if programmed.

When calling in personal format, the system will swap between the primary and backup numbers (if programmed) every alternating call that fails. If the temporary number is programmed it will be used instead of the primary number.

The Fail to Communicate input will be triggered when the dialler has made the programmed number of unsuccessful attempts set at address 242. If enabled, Fail To Communicate may trigger the siren and the strobe as long as a Zone alarm has occurred since the panel was last armed.

## AUTOMATIC TEST REPORTS.

The following addresses must be programmed for test reports to function correctly.

### Address 090 (Test Input)

Address 090 enables the test report input. Enable options 3 (for dialler) and 8 (for 24hr) at this address to enable test reports.

### Address 106 (Test Time)

Sets the time between test reports. (From 0 - 165 hours).

To program test times of greater than 99 hours use the **#** key sequence. See page 31.

### Address 246 (Test Report Delay)

If a time is programmed in address 246 (Test Report Delay), then the first test report will occur that many hours after you perform a panel reset.

The reason for delaying the first test report is to set the time of day when the panel will actually send test reports. Most central stations prefer test reports to be sent during non-peak hours, i.e., midnight to 6am. If a Test Report Delay is not set, the panel will send test reports at the intervals programmed by the test time starting when the panel is reset after programming.

*Example:* If you program Test Reports for 24hrs and you are installing and programming the panel at 4pm. Then test reports will be sent at 4pm every day; this time may not suit the central station. To make the panel send test reports at 3am every day, program address 246 (Test Report Delay) for 11 hours. Therefore if the panel is programmed and reset at 4pm, the first test report will follow 11 hours later at 3am. From there on, test reports will follow every 24hrs.

### Address 108 (Trim Time)

The Trim Time option can be used to make the time reporting period more accurate. Setting Trim Time to a number other than 00 will reduce the time between test reports by that many minutes. For example if the Test Time was set to 12 (hours) but the reports were actually 12 hours, 7 minutes apart, then setting Trim Time to 07 would correct the error.

**Note 1:** If the test input is enabled, pressing key **#** followed by key **3** will manually trigger a test report.

**Note 2:** When you have finished programming, reset the panel (address 254) to enable new settings.

### Test report programming - Step by step

1. At address 090, enable test reporting by turning on options 3 and 8.
2. At address 106, enter the number of hours you would like between test reports.
3. At address 246, enter the numbers of hours to delay the first test report.
4. Reset the panel by entering 254 while in program mode.
5. [At this stage the system will pick up the phone line and send a test report. This initialises the test reporting timer. The “first” test report will be delayed by the number of hours programmed at address 246.]

**BASE STATION MONITORED REPORTING****HIGH SPEED**

The system sends Ademco high speed reports in extended format. This format is pre-set and requires no further programming.

**CONTACT ID**

Ademco Contact ID allows Zone descriptive information to be sent to the Central Station. There are about 200 or so standard messages to choose from, each message has a 3 digit identifier. The system allows you to choose a 3 digit message for every logical input. The messages start at address 176. Each message must be 3 digits. For a complete list of all possible messages, contact your Central Station.

Zone bypass uses the fixed message "570" which will be displayed at the central station as "Zone Bypass".

User reporting codes are the same as for Ademco fast format and are listed below:

<b>Code reported</b>	<b>Caused by</b>
Code F	Code 15 on/off
Code E	Panel on reset or Code 14 on/off
Code D	Quick-arm sequence or Code 13 on/off
Code C	Key-switch or Code 12 on/off
Codes 0 to B	Code 0 to Code 11 on/off

*Another Quality Product By:*



17 Millicent St, Burwood, Vic 3125 Australia  
Telephone: (03) 9888 9889 Facsimile: (03) 9888 9993  
e-mail: enquiry@psaproducts.com.au  
website: www.psaproducts.com.au



Quality System  
Quality Endorsed Company  
ISO 9001 Lic. 5280  
SAI (QMS)

This manual applies to Pinkerton software version 23  
Issued: October 2006

PSA guarantees against faulty workmanship and/or material for a period of 12 months from the date of manufacture or purchase. This guarantee is limited to the replacement or repair of the faulty part and does not cover damage to other property which may have occurred due to the failure of the faulty part or cost of removing the faulty part from any duct or building which it is installed and/or replaced therein. The warranty does not apply if goods are damaged in transit, the purchaser interferes with, modifies or damages the goods or uses the goods in connection with other products not authorized by PSA. The product is exposed to harsh and unusual environmental conditions. Misuse of the product will also void the warranty of the product.